

**SM-600-GREENLINE / SM-600-GREENLINE-Power
SM-600-GREENLINE-POWER-FFS**



- DE | Betriebsanleitung
- GB | Operating Instructions
- FR | Instructions d'emploi
- IT | Istruzioni d'uso

**SM-600-GREENLINE / SM-600-GREENLINE-Power
SM-600-GREENLINE-POWER-FFS**



DE | Betriebsanleitung

Inhaltsverzeichnis

1	Sicherheitshinweise	4
1.1	Klassifikation der Sicherheitshinweise	4
1.2	Warnhinweise	5
1.3	Gebotszeichen	5
1.4	Sicherheitskennzeichnung	6
1.5	Bestimmung dieser Anleitung	7
1.6	Allgemeine Sicherheitshinweise	8
1.7	Sicherheit im Betrieb	10
1.7.1	Allgemein	10
1.8	Besondere Gefahren	11
1.9	Bestimmungsgemäße Verwendung	11
1.10	Pflichten des Betreibers	13
1.11	Anforderungen an den Aufstellort/Arbeitsplatz	15
1.11.1	Anforderungen an den Aufstellort	15
1.11.2	Anforderungen an den Arbeitsplatz	15
1.12	Definition des Gefahrenbereichs	16
1.13	Emissionen	17
1.14	Persönliche Schutzausrüstung	18
1.14.1	Installation/Außerbetriebnahme und Entsorgung des Hebeegeräts	18
1.14.2	Bedienung des Hebeegeräts	18
1.14.3	Störungsbehebung/Wartung des Hebeegeräts	18
2	Produktbeschreibung	19
2.1	Bestandteile	19
2.2	Bedienelemente	21
2.3	Typenschild	23
2.4	Vakuumerzeuger	23
2.5	Saugplatten	23
2.6	Sicherheitseinrichtungen	23
3	Technische Daten	24
3.1	Technische Daten der Funkfernsteuerung (nur SM-600-POWER-FFS)	24
4	Anlieferung, Verpackung und Transport	25
4.1	Anlieferung	25
4.1.1	Lieferumfang	25
4.1.2	Vollständigkeit prüfen	25
4.1.3	Schäden melden	25
4.2	Verpackung	25
4.3	Transport	25
4.4	Entnahme Hebeegeräts von der Palette	26

5	Inbetriebnahme	27
5.1	Werkzeugliste	27
5.2	Hebegerät anschlagen	27
5.3	Montage der Saugplatte am Hebegerät	27
5.4	Wechseln der Saugplatte	29
5.5	Energieversorgung	29
6	Betrieb	30
6.1	Allgemeine Sicherheitshinweise zum Betrieb	30
6.2	Prüfungen vor Arbeitsantritt	32
6.3	Verhalten im Notfall	32
6.4	Option Funkfernsteuerung	33
6.5	Last anheben – Ansaugen	33
6.6	Last führen	35
6.7	Last ablegen – Lösen	36
6.8	Hebegerät parken	37
7	Lagerung	38
8	Störungsbehebung	39
9	Wartung	40
9.1	Allgemeine Hinweise	40
9.2	Akku austauschen	40
9.3	Vakuumerzeuger	40
9.4	Saugplatten / Dichtlippen	41
9.5	Sicherheitseinrichtungen prüfen	41
9.5.1	Blitzleuchte prüfen	41
9.5.2	Saugschläuche und -klemmen prüfen	41
9.5.3	Dichtheit prüfen	42
9.6	Filter	43
9.7	Kondenswasser ablassen	43
9.8	Wartungsplan	44
9.8.1	Mechanik	44
9.8.2	Übrige Bauelemente	44
9.9	Jährliche Prüfung	45
9.10	Reinigung	46
9.11	Ersatzteile	46
10	Außerbetriebnahme und Entsorgung	46

EG-Konformitätserklärung

Bezeichnung: Steinmagnet SM
Typ: SM-600-GREENLINE / SM-600-GREENLINE-Power SM-600-
GREENLINE-POWER-FFS
Artikel-Nr.: 52720006 / 52720007 / 52720008



Hersteller: Probst GmbH
Gottlieb-Daimler-Straße 6
71729 Erdmannhausen, Germany
info@probst-handling.de
www.probst-handling.com

Die vorstehend bezeichnete Maschine entspricht den einschlägigen Vorgaben nachfolgender EU-Richtlinien:

2006/42/EG (Maschinenrichtlinie)

2014/30/EU (Elektromagnetische Verträglichkeit)

Folgende Normen und technische Spezifikationen wurden herangezogen:

DIN EN ISO 12100

Sicherheit von Maschinen - Allgemeine Gestaltungsleitsätze - Risikobeurteilung und Risikominderung

2014/30/EU (Elektromagnetische Verträglichkeit)

DIN EN ISO 13857

Sicherheit von Maschinen - Sicherheitsabstände gegen das Erreichen von Gefährdungsbereichen mit den oberen und unteren Gliedmaßen (ISO 13857:2008).

DIN EN 1012-1 / DIN EN 1012-2

Kompressoren und Vakuumpumpen; Sicherheitsanforderungen Teil 1 und 2.

DIN EN 60204-1 (IEC 60204-1)

Sicherheit von Maschinen, Elektrische Ausrüstung von Industriemaschinen. Teil 1: Allgemeine Anforderungen

Dokumentationsbevollmächtigter:

Name: Jean Holderied

Anschrift: Probst GmbH; Gottlieb-Daimler-Straße 6; 71729 Erdmannhausen, Germany

Unterschrift, Angaben zum Unterzeichner:

Erdmannhausen, 05.03.2024.....

(Eric Wilhelm, Geschäftsführer)

1 Sicherheitshinweise

1.1 Klassifikation der Sicherheitshinweise

Gefahr

Dieser Warnhinweis warnt vor einer Gefahr, die zum Tod oder schweren Verletzungen führt, wenn sie nicht vermieden wird.

 GEFAHR	
	Art und Quelle der Gefahr Folge der Gefahr ► Gefahrenabhilfe

Warnung

Dieser Warnhinweis warnt vor einer Gefahr, die zum Tod oder schweren Verletzungen führen kann, wenn sie nicht vermieden wird.

 WARNUNG	
	Art und Quelle der Gefahr Folge der Gefahr ► Gefahrenabhilfe

Vorsicht

Dieser Warnhinweis warnt vor einer Gefahr, die zu Verletzungen führen kann, wenn sie nicht vermieden wird.

 VORSICHT	
	Art und Quelle der Gefahr Folge der Gefahr ► Gefahrenabhilfe



Achtung

Dieser Warnhinweis warnt vor einer Gefahr, die zu Sachschäden führen kann, wenn sie nicht vermieden wird.

ACHTUNG	
	Art und Quelle der Gefahr Folge der Gefahr ► Gefahrenabhilfe





1.2 Warnhinweise

Erläuterung der in der Betriebs- und Wartungsanleitung verwendeten Warnzeichen.







Warnzeichen	Beschreibung	Warnzeichen	Beschreibung
	Allgemeines Warnzeichen		Warnung vor explosionsfähiger Atmosphäre
	Warnung vor Handverletzungen		Warnung vor herumfliegenden Teilen
	Warnung vor schwebender Last		Warnung vor Quetschgefahr
	Warnung vor Unterdruck		Warnung vor Absturzgefahr
	Warnung vor herabfallenden Teile		Warnung vor Gehörschäden

1.3 Gebotszeichen

Erläuterung der in der Betriebs- und Wartungsanleitung verwendeten Gebotszeichen.

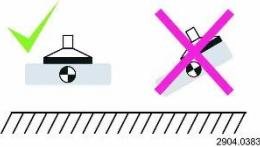
Gebotszeichen	Beschreibung	Gebotszeichen	Beschreibung
	Gehörschutz benutzen		Sicherheitsschuhe benutzen
	Handschutz benutzen		Netzstecker ziehen
	Bedienungsanleitung beachten		Augenschutz benutzen

1.4 Sicherheitskennzeichnung

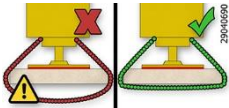
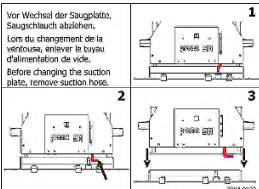
VERBOTSZEICHEN				
Symbol	Bedeutung	Bestell-Nr.:		
	Niemals unter schwebende Last treten. Lebensgefahr!	2904.0209	50 mm	
	Die angesaugte Last darf keinesfalls OHNE zusätzliche Sicherung durch die Lastsicherungskette angehoben und transportiert werden.	2904.0767	55 x 25 mm	
	Produkte niemals außermittig aufnehmen.	2904.0383		
WARNZEICHEN				
Symbol	Bedeutung	Bestell-Nr.:	Größe:	
	Quetschgefahr der Hände.	2904.0220	50 mm	
	Hinweis auf funkferngesteuertes Gerät	2904.0647	130 x 50 mm	
(optional)				
GEBOTSZEICHEN				
Symbol	Bedeutung	Bestell-Nr.:	Größe:	
	Jeder Bediener muss die Bedienungsanleitung für das Gerät mit den Sicherheitsvorschriften gelesen und verstanden haben.	2904.0665 2904.0666	30 mm 50 mm	
	Lastsicherheitsketten müssen straff an der Last anliegen. Lastsicherheitsketten dürfen niemals locker unter der Last hängen!	2904.0690	25 x 55 mm	
	Vor Wechsel der Saugplatte, Saugschlauch abziehen.	2904.0322	65 x 88 mm	

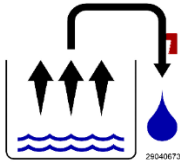

Täglich Kondenswasser am Gerät ablassen.

2904.0673

40 x 40 mm

HINWEISZEICHEN

Symbol	Bedeutung	Bestell-Nr.:	Größe:
 <p>(optional)</p>	Last ansaugen u. lösen	2904.0320	25 x 60 mm



1.5 Bestimmung dieser Anleitung



! WARNUNG	
	<p>Unfallgefahr bei Nicht-Beachtung der Hinweise</p> <ul style="list-style-type: none"> ▶ Diese Betriebs- und Wartungsanleitung ist fester Bestandteil der Hebegeräte Steinmagnet „Standard“ und „Power“ und enthält wichtige Informationen zu ihrer Anwendung. ▶ Die Betriebs- und Wartungsanleitung ist auf den Lieferumfang der Fa. Probst abgestimmt. Kundenseitige Änderungen des Systems sind dabei nicht berücksichtigt und grundsätzlich untersagt. ▶ Nutzung, Anschluss und Inbetriebnahme dürfen erst erfolgen, nachdem die Betriebs- und Wartungsanleitung gelesen und verstanden wurde!



1.6 Allgemeine Sicherheitshinweise



Das Hebegerät der Serie **STEINMAGNET**, im Folgenden Hebegerät genannt, ist nach dem neuesten Stand der Technik gebaut und betriebssicher, sofern die Bestimmungen dieser Anleitung eingehalten werden. Bei falschem Umgang mit dem Hebegerät können Gefahren davon ausgehen.

 WARNUNG	
	<p>Unfallgefahr durch Nicht-Beachtung der allgemeinen Sicherheitshinweise</p> <ul style="list-style-type: none"> ▶ Nur vorgesehene Anschlussmöglichkeiten, Befestigungsbohrungen und Befestigungsmittel verwenden. ▶ Montage oder Demontage ist nur in drucklosem Zustand zulässig. ▶ Bei Arbeiten am Hebegerät hat der Bediener dafür zu sorgen, dass der Zugriff auf das verwendete Transport- oder Hubmittel (Kran, Kettenzug, Baustellenfahrzeug, ...) unterbunden ist, so dass keine Bewegung stattfinden kann. ▶ Installations-, Wartungs- und Reparaturarbeiten dürfen nur durch qualifiziertes Fachpersonal und Mechaniker erfolgen, wenn sie aufgrund ihrer Kenntnisse und Erfahrungen sowie der Kenntnis der einschlägigen Bestimmungen die ihnen übertragenen Arbeiten beurteilen, mögliche Gefahren erkennen und geeignete Sicherheitsmaßnahmen treffen können! ▶ Allgemeine Sicherheitsvorschriften und EN-Normen müssen beachtet und eingehalten werden! ▶ Aufenthalt von Personen oder Tieren im Gefahrenbereich ist verboten! ▶ Das Hebegerät darf nur bestimmungsgemäß eingesetzt werden (Kap. 1.9). ▶ Mit dem Hebegerät dürfen nur geeignete Lasten gehoben und transportiert werden. ▶ Sie sind im Arbeitsbereich des Hebegerätes Dritten gegenüber mitverantwortlich, daher müssen die Zuständigkeiten für die unterschiedlichen Tätigkeiten am System klar festgelegt sein und eingehalten werden. Es dürfen keine unklaren Kompetenzen auftreten. ▶ Es dürfen zu keiner Zeit Flüssigkeiten oder Schüttgüter durch das Hebegerät gesaugt werden. ▶ Die Bauteile sind generell vor Beschädigungen jeglicher Art zu schützen!

 WARNUNG	
 	<p>Unfallgefahr durch Nicht-Beachtung der allgemeinen Sicherheitshinweise</p> <p>Schaden an Personen / Anlagen / Systemen</p> <ul style="list-style-type: none"> ▶ Die zulässige Belastungsgrenzen sind im Kapitel Technische Daten definiert und dürfen nicht unter- oder überschritten werden. ▶ Die Sicherheitseinrichtungen müssen in einwandfreiem Zustand und für den Prozess zugeschaltet eingerichtet sein.

 WARNUNG	
	<p>Verletzungsgefahr durch offenliegende Vakuumsaugstellen</p> <ul style="list-style-type: none">▶ Nicht in die Saugstellen hineinsehen, -hören oder anderweitig in die Nähe von Körperöffnungen bringen oder hineinfassen.▶ Das Gerät erzeugt einen sehr starken Sog, der Haare und Kleidungsstücke einsaugen kann.

	<p>Befolgen Sie stets alle geltenden Gesetze und Vorschriften.</p> <p>Bei der Benutzung des Hebeegeräts sind die gesetzlichen Regelungen, Sicherheitsvorschriften, Normen und Richtlinien am Einsatzort einzuhalten. Bei den zuständigen Behörden sind diese zu erfragen. Die Sicherheitshinweise in dieser Betriebs- und Wartungsanleitung heben diese nicht auf, sondern sind ergänzend zu betrachten.</p>
-----------------------------------------------------------------------------------	---------------------------------------------------------------------------------------------------------------------------------------------------------------------------------------------------------------------------------------------------------------------------------------------------------------------------------------------------------------------------------------------------------------------

1.7 Sicherheit im Betrieb

1.7.1 Allgemein



Verbot

- ▶ **Das Arbeiten mit diesem Gerät darf nur in bodennahem Bereich erfolgen.** Die angesaugte Last **muss** unmittelbar nach dem Aufnehmen (z.B. von einer Palette oder von einem LKW) bis knapp über den **Boden abgesenkt werden** (ca. 20 - 30 cm). Anschließend ist die **Last** durch die **Lastsicherungskette zusichern** und darf **erst dann** zur Verlegestelle transportiert werden. Last zum Transportieren nur so hoch wie nötig anheben (Empfehlung ca. 0,5 m über Boden).



Das Schwenken des Gerätes über Personen hinweg ist untersagt. Lebensgefahr!

- ▶ Das manuelle Führen ist nur bei Geräten mit Handgriffen erlaubt.
- ▶ Der Bediener darf den Steuerplatz nicht verlassen, solange das Gerät mit Ladung belastet ist und muss die Ladung immer im Blick haben.
- ▶ Der Bediener muss das Manometer stets im Auge behalten. Last (z.B. Steinplatte) **nur** anheben, wenn der erforderliche Vakuum-Unterdruck erreicht ist. Wenn der Zeiger des Manometers sich in den roten Bereich unter dem erforderlichen Vakuum-Unterdruck bewegt, **Last sofort absetzen. Lebensgefahr – Last wird herabfallen!**



Verbot

- Während des Betriebes ist der Aufenthalt von Personen im Arbeitsbereich **verboten!** Es sei denn es ist unerlässlich. Bedingt durch die Art der Geräteanwendung, z.B. durch manuelles Führen des Gerätes (an Handgriffen).
- Der Aufenthalt unter schwebender Last ist verboten. **Lebensgefahr!**
- Lasten niemals schräg ziehen oder schleifen.
- Die Last niemals außermittig ansaugen, ansonsten **Kippgefahr.**



- Last erst von der Saugplatte ablösen, wenn sie vollständig und sicher am Boden aufliegt oder steht.
- Finger weg von der Last beim Lösen. Quetschgefahr!**

- Die Tragfähigkeit und Nennweiten/Nenngrößen des Gerätes dürfen nicht überschritten werden.
- Festsitzende Lasten nicht mit dem Gerät losreißen.



Verbot

- **Ruckartiges Anheben oder Absenken** des Gerätes mit und ohne Last ist **verboten!** Unnötige Erschütterungen sind zu vermeiden. So wie das schnelle Fahren mit dem Trägergerät/ Hebezeug über unebenes Gelände!
Lebensgefahr: Last könnte dadurch herunterfallen, oder Lastaufnahmemittel beschädigt werden!
Generell darf mit angehobener Last nur mit **Schrittgeschwindigkeit** gefahren werden!

1.8 Besondere Gefahren





Verbot



- ▶ Arbeitsbereich für unbefugte Personen, insbesondere Kinder, weiträumig absichern.
- ▶ Arbeitsbereich ausreichend beleuchten.
- ▶ Vorsicht bei nassen, angefrorenen oder verschmutzten Baustoffen.
- ▶ Vorsicht bei Gewitter!
- ▶ **Das Arbeiten mit dem Gerät bei Witterungsverhältnissen unter 3 ° C (37,5° F) ist verboten! Es besteht die Gefahr des Herabfallens der Last bedingt durch Nässe oder Vereisung.**
- ▶ Da die Last durch Unterdruck an den Saugplatten des Gerätes gehalten wird, fällt sie herab, sobald der Unterdruck zusammenbricht (z.B. bei Energieausfall).
- ▶ Setzen Sie die Last bei Ausfällen wenn möglich sofort ab. Andernfalls entfernen Sie sich sofort aus dem Gefahrenbereich. **Lebensgefahr**

1.9 Bestimmungsgemäße Verwendung

Das Hebegerät dient zum bodennahen (siehe Kapitel „Sicherheit im Betrieb“) Heben und Transportieren von flachen, dichten und nicht porösen Steinplatten aus Granit, Marmor, WET CAST etc., sowie Betonelementen, Natursteinen, Sandsteinen Trittstufen, Steinzeugrohren usw. (sofern eine Unterdruck von -0,6 bar erreichbar ist) mit Hilfe von geeigneten Transport- oder Hubmitteln (Kran, Kettenzug, Baustellenfahrzeug, ...).

 WARNUNG	
	<p>Gefahr durch herabfallende Gegenstände wegen Verwendung einer ungeeigneten Saugplatte.</p> <ul style="list-style-type: none"> ▶ Die Saugplatte ist nicht Teil des Lieferumfangs. Der Betreiber hat sicherzustellen, dass nur Saugplatten verwendet werden, die für die zu hebende Last geeignet sind. Maximale Traglast 600 kg. ▶ Die Saugplattenbefestigung muss den im Kap. 5.3 genannten Anforderungen gehorchen. Andere Saugplattenbefestigungen sind nicht zugelassen. ▶ Die Ansaugfläche der zu hebenden Last muss saugdicht sein, d.h. wenn die Energieversorgung abgeschaltet wird, muss die gegriffene Last noch 5 Minuten gehalten werden. Dies ist gegebenenfalls durch Versuche abzusichern.

Die Last (Steinplatte), die angesaugt und transportiert werden soll, muss genügend Eigenstabilität aufweisen, da ansonsten **Bruchgefahr** beim Anheben besteht! Steinplatten dürfen sich beim Anheben **keinesfalls** durchbiegen – darauf ist besonders bei dünnen und großformatigen Steinplatten zu achten!

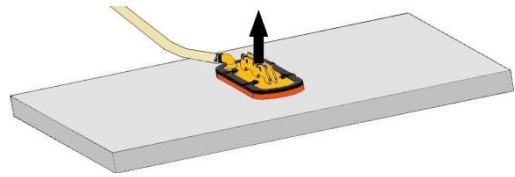

Lasten (Steinplatten) nur **mittig** ansaugen, da sonst die Last schief am Hebegerät hängt was zum Bruch der Last führen kann - speziell beim Anheben von großformatigen Steinplatten mit einer kleinen Saugplatte. Standardsaugplatten sind nicht für den Transport von Glasscheiben geeignet!

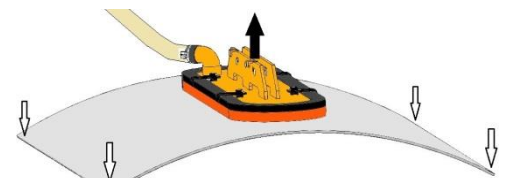

GEFAHR

Saugplatten haben verschiedene Traglasten

Gefahr durch herabfallende Last (Steinplatte)

- ▶ Einige der Saugplatten, die an das Gerät angebaut werden können, reduzieren seine Tragfähigkeit.

Auf jeder Saugplatte ist die zulässige Traglast angegeben.

Es dürfen nur Saugplatten des Herstellers Probst verwendet werden!

- ▶ Das Überschreiten der zulässigen und der angegebenen Traglast der Saugplatten ist strengstens untersagt !



Das Hebegerät wird ohne Saugplatte ausgeliefert.

Der Kunde ist verpflichtet, ein Konformitätsbewertungsverfahren gemäß Art. 12 der Maschinenrichtlinie 2006/42 durchzuführen (siehe auch Kap. 5.3).

Die zulässigen Belastungsgrenzen sind im Kapitel 3 (Technische Daten) definiert und dürfen nicht unter- oder überschritten werden. Beachten Sie hierzu auch das Typenschild bzw. die Traglast-Aufkleber!

Das Hebegerät darf nicht eigenständig umgebaut oder verändert werden. Es darf nur im Original-Auslieferungszustand betrieben werden.





WARNUNG



Es besteht die Gefahr, dass durch Herabfallen der Last Körperteile gequetscht oder Personen erschlagen werden.

Durch eigenmächtige Umbauten und Veränderungen verliert das Hebegerät die benötigte Integrität. Seine Funktion kann nicht mehr gewährleistet werden.

- ▶ Keine bauseitigen Änderungen am System vornehmen



 WARNUNG	
	<p>Lebensgefahr durch Herabstürzen bei Verwendung als Transportmittel für Mensch und Tier, oder als Steighilfe.</p> <p>Knochenbrüche, schwerste Verletzungen und Tod sind die Folge.</p> <p>▶ Das Verwenden des Hebeegerätes als Steighilfe oder zum Transport von Menschen und Tieren ist verboten!</p>

1.10 Pflichten des Betreibers

Das Hebegerät darf nur von qualifizierten Fachkräften und Mechanikern installiert, gewartet und repariert werden.

Eine Fachkraft ist: Wer aufgrund seiner fachlichen Ausbildung, seiner Kenntnisse und Erfahrungen, sowie seiner Kenntnisse der einschlägigen Bestimmungen, die ihm übertragenen Arbeiten beurteilen, mögliche Gefahren erkennen und geeignete Sicherheitsmaßnahmen treffen kann. Eine Fachkraft muss die einschlägigen fachspezifischen Regeln einhalten.

	<p>Der Betrieb des Anwenders muss durch innerbetriebliche Maßnahmen sicherstellen, dass jede Person, die im Betrieb des Anwenders mit der Aufstellung, Inbetriebnahme, Bedienung, Wartung und Reparatur des Hebeegeräts beauftragt ist, nur Versicherte beschäftigt,</p> <ul style="list-style-type: none"> • die das 18. Lebensjahr vollendet haben, die körperlich und geistig geeignet sind, • die im Führen oder Instandhalten des Hebeegeräts unterwiesen sind, • die Betriebs- und Wartungsanleitung gelesen und verstanden haben, • und von denen zu erwarten ist, dass sie die ihnen übertragenen Aufgaben zuverlässig erfüllen. <p>Die Betriebs- und Wartungsanleitung muss jederzeit zugänglich sein und für spätere Zwecke aufbewahrt werden.</p>
-------------------------------------------------------------------------------------	--------------------------------------------------------------------------------------------------------------------------------------------------------------------------------------------------------------------------------------------------------------------------------------------------------------------------------------------------------------------------------------------------------------------------------------------------------------------------------------------------------------------------------------------------------------------------------------------------------------------------------------------------------------------------------------------------------------------------------------------------------------------------------------------------------

 WARNUNG	
	<p>Verletzungsgefahr durch Fehlanwendung oder Missachtung von Warn- und Sicherheitshinweisen.</p> <p>▶ Benutzung nur durch geschultes Personal. ▶ Pausenregelung gemäß der örtlichen Bestimmungen, um Unfälle aufgrund von Unachtsamkeit zu vermeiden.</p>

- Das Hebegerät muss vor jedem Einsatz auf Funktion und Zustand geprüft werden (siehe Kap. 0).
- Wartung, Schmierung und Störungsbeseitigung dürfen nur bei stillgelegtem Hebegerät erfolgen!
- Bei Mängeln, die die Sicherheit betreffen, darf das Hebegerät erst nach einer kompletten Mängelbeseitigung wieder eingesetzt werden.
- Bei Rissen an tragenden Teilen muss das Hebegerät sofort jeglicher Nutzung entzogen werden.
- Die Betriebsanleitung für das Hebegerät muss am Einsatzort jederzeit einsehbar sein.
- Das am Hebegerät angebrachte Typenschild darf nicht entfernt werden.

- Unlesbare Hinweisschilder sind auszutauschen.

1.11 Anforderungen an den Aufstellort/Arbeitsplatz

1.11.1 Anforderungen an den Aufstellort

 GEFAHR	
	<p>Nicht explosionsgesicherte Schaltbauteile Brand- und Explosionsgefahr</p> <p>▶ Das Hebegerät darf nicht in explosionsgefährdeten Bereichen eingesetzt werden.</p>

 WARNUNG	
	<p>Explosionsgefahr durch Einsaugen von entzündlichen Stoffen</p> <p>▶ Vor dem Aufsetzen des Hebegerätes sicherstellen, dass keine entzündlichen Stoffe (Treibstoffe, Lösungsmittel usw.) eingesaugt werden können.</p>

ACHTUNG	
	<p>Beschädigung des Hebegerätes durch Betrieb in Bereichen mit säure- oder laugenhaltigen Medien bzw. mit belasteter Atmosphäre.</p> <p>▶ Vor Betrieb in einer Umgebung mit aggressiver Atmosphäre Rücksprache mit dem Hersteller halten.</p>

Das Hebegerät kann von 3°C bis +40°C betrieben werden.

ACHTUNG	
	<p>Beschädigung des Hebegeräts durch Benutzung außerhalb des zugelassenen Temperaturbereichs</p> <p>▶ Hebegerät nur bei zugelassener Umgebungstemperatur einsetzen.</p> <p>▶ Vor Betrieb außerhalb des zugelassenen Temperaturbereichs Rücksprache mit dem Hersteller halten.</p>

1.11.2 Anforderungen an den Arbeitsplatz



Der Arbeitsplatz des Bedieners befindet sich am Haltegriff. Sicherstellen, dass der Bediener das komplette Arbeitsumfeld kontinuierlich überwachen kann. Der Arbeitsplatz muss ausreichend und blendfrei beleuchtet sein.

Durch entsprechende innerbetriebliche Anweisungen und Kontrollen sicherstellen, dass die Umgebung des Arbeitsplatzes stets sauber und übersichtlich gestaltet ist.

ACHTUNG	
	<p>Beschädigung des Hebegeräts durch Einsaugen von Kleinteilen</p> <p>▶ Der Einsatzort und das Umfeld des Hebegeräts sind von einsaugbaren Kleinteilen frei zu halten.</p>

1.12 Definition des Gefahrenbereichs



- Gefahrenbereich ist der Bereich innerhalb oder im Umkreis eines Arbeitsmittels, in dem die Sicherheit oder die Gesundheit von sich darin aufhaltenden Personen gefährdet ist oder gefährdet sein könnte.
- Beim Anheben der Last oder beim Transport besteht die Möglichkeit, dass die Last und das Hebegerät herabfallen oder abgesenkt werden. Deshalb ist grundsätzlich der Bereich direkt unter dem Hebegerät ein Gefahrenbereich.
- Beim horizontalen Transport ist zu beachten, dass durch Anheben, horizontales Beschleunigen und Abbremsen der Last z.B. eine Drehung, Schiefstellung oder Pendelbewegung eintritt. Daher ist die Umgebung der Last ein Gefahrenbereich.
- Daher ist auch beim Führen der Last durch den Anschläger ein entsprechender Sicherheitsabstand notwendig (immer den Haltegriff zum Führen der Last verwenden).
- Nicht vor der Last gehen – durch z.B. unerwartete Hindernisse besteht Stolpergefahr und die Last fährt auf Sie zu. Auch beim Abstoppen der horizontalen Fahrbewegung pendelt die Last in ihre Richtung. Ein gleichzeitiges beobachten/überwachen des Transportweges und der Last ist nicht möglich.
- Der Gefahrenbereich beim Lastabsturz hängt im Wesentlichen von der Transporthöhe ab und ist schwer einzuschätzen. Lasten sollten grundsätzlich so bodennah wie möglich gehalten werden.

 WARNUNG	
	<p>Verletzungsgefahr durch herabfallende Gegenstände wenn</p> <ul style="list-style-type: none"> - der Unterdruck zusammenbricht - die Last durch Kollision absichert - Bauteile durch Fehl- und Überbelastung oder unzulässige Umbauten versagen. <p>Personen werden getroffen und verletzt oder erschlagen!</p> <ul style="list-style-type: none"> ▶ Arbeitsbereich weiträumig für unbefugte Personen, insbesondere Kinder absichern. ▶ Vor jedem Transportvorgang muss die Last mit der Lastsicherungskette gesichert werden. ▶ Der Aufenthalt unter schwebender Last ist verboten. ▶ Nur bei guter Sicht über den ganzen Arbeitsbereich arbeiten. ▶ Auf andere Personen im Arbeitsbereich achten. ▶ Last nie über Personen hinweg befördern. ▶ Der Schwerpunkt der Last muss sich stets im Arbeitsbereich des Transport- oder Hubmittels (Kran, Kettenzug, Baustellenfahrzeug, ...) ▶ Haltegriff des Hebegerät nicht loslassen, solange eine Last gehoben ▶ Der Bediener/Betreiber muss den Arbeitsbereich absichern. Die dafür notwendigen Personen bzw. Einrichtungen sind während des Hebe-/Transportvorgangs bereitzustellen.

1.13 Emissionen



Das Hebegerät emittiert Schall und Abluft.

Der vom Gerät ausgehende äquivalente Dauerschalldruckpegel liegt unter 70 dB(A).

 VORSICHT	
 	<p>Lärmbelastung durch Vakuum-Erzeuger</p> <p>Durch die Lärmbelastung kann es zu Hörschäden kommen.</p> <p>▶ Gehörschutz tragen</p>

Angesaugte Medien werden durch den Vakuumerzeuger zerstäubt und verteilt. Deshalb darf keine verunreinigte oder kontaminierte Umgebungsluft (Partikelgröße max. 5µm) angesaugt werden.

 VORSICHT	
	<p>Vergiftungsgefahr durch Emission von eingesaugten Abgasen.</p> <p>▶ Vor dem Einschalten des Hebegebietes sicherstellen, dass keine Abgase eingesaugt werden können.</p>

 VORSICHT	
	<p>Gefahr von Augenverletzungen</p> <p>Alle Vakuum-Erzeuger erzeugen einen Abluftstrom. Abhängig von der Reinheit der Umgebungsluft kann diese Abluft Partikel enthalten, die mit hoher Geschwindigkeit aus der Abluftöffnung austreten und Menschen im Gesichts- und Augenbereich verletzen</p> <p>▶ Nicht in den Abluftstrom blicken.</p> <p>▶ Schutzbrille tragen.</p>

1.14 Persönliche Schutzausrüstung

Tragen Sie stets geeignete Schutzausrüstung!

1.14.1 Installation/Außerbetriebnahme und Entsorgung des Hebeegeräts

- Sicherheitsschuhe (nach EN 20345 Sicherheitsklasse S1 oder besser)
- Feste Arbeitshandschuhe (nach EN 388 Sicherheitskategorie 2133 oder besser)
- Industriehelm (nach EN 397)
- Gehörschutz (nach EN 352 Klasse L oder höher)
- Weitere, der Situation angepasste oder durch nationale Vorschriften vorgeschriebene Schutzausrüstung.

1.14.2 Bedienung des Hebeegeräts

- Sicherheitsschuhe (nach EN 20345 Sicherheitsklasse S1 oder besser)
- Feste Arbeitshandschuhe (nach EN 388 Sicherheitskategorie 2133 oder besser)
- Industriehelm (nach EN 397)
- Weitere, der Situation angepasste oder durch nationale Vorschriften vorgeschriebene Schutzausrüstung.

1.14.3 Störungsbehebung/Wartung des Hebeegeräts

- Sicherheitsschuhe (nach EN 20345 Sicherheitsklasse S1 oder besser)
- Feste Arbeitshandschuhe (nach EN 388 Sicherheitskategorie 2133 oder besser)
- Schutzbrille (Klasse F)
- Gehörschutz (nach EN 352 Klasse L oder höher)
- Weitere, der Situation angepasste oder durch nationale Vorschriften vorgeschriebene Schutzausrüstung.

2 Produktbeschreibung

2.1 Bestandteile

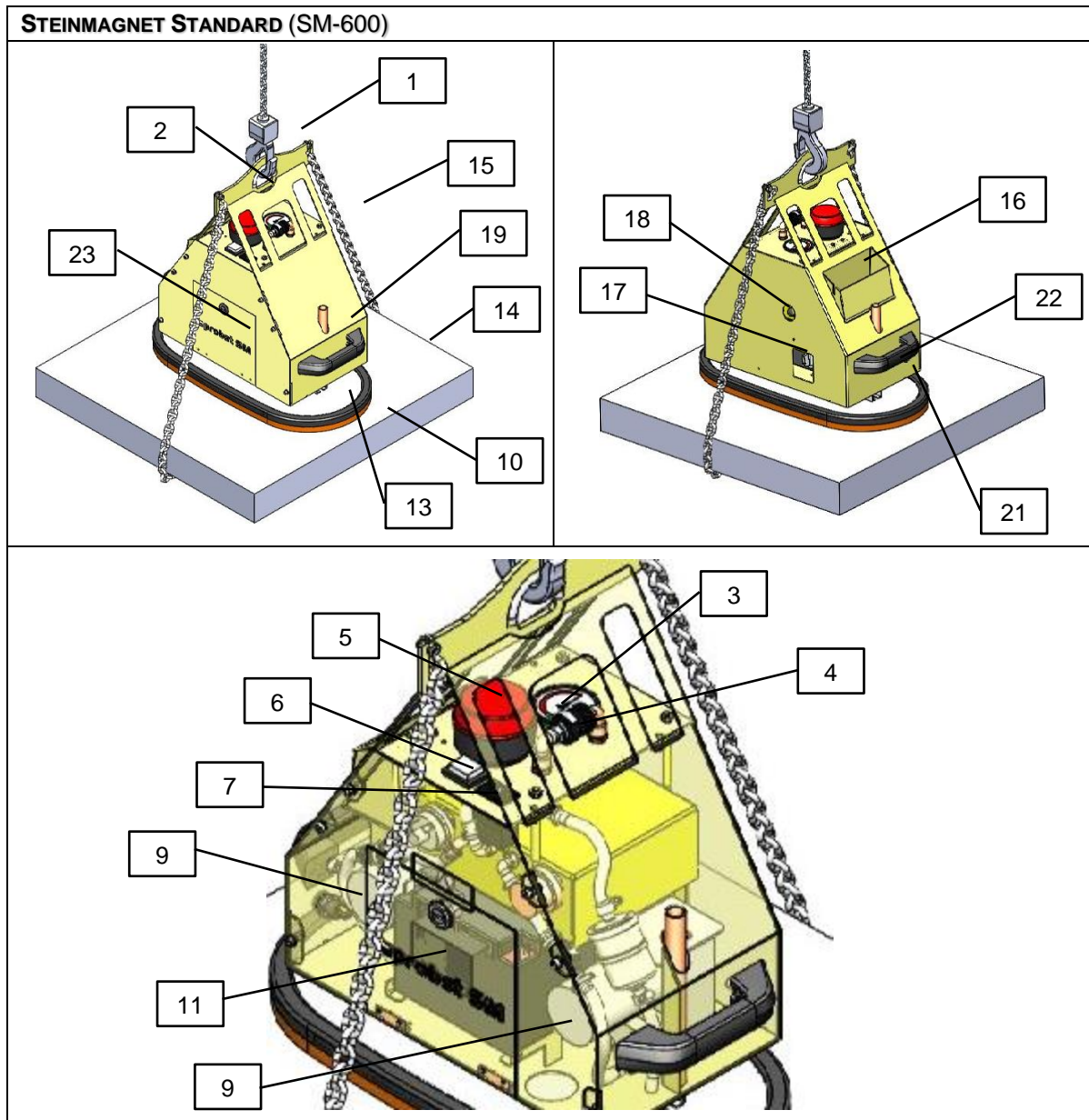

Pos.	Beschreibung	Pos.	Beschreibung
1	Kranhaken (nicht im Lieferumfang)	12	Schmutzfilter
2	Aufhängung	13	C-Schiene der Saugplatte (nicht im Lieferumfang)
3	Vakuummanometer	14	Last (Steinplatte)
4	Handschiebeventil	15	Lastsicherungskette
5	Rote Blitzleuchte	16	Kettenkasten
6	Ein-/Ausshalter (mit 3 Stellungen)	17	Ablass-Ventil
7	Ladezustandsanzeige Akku	18	Schauglas
8	Gehäuse mit Sicherheitsspeicher	19	Befestigungsbohrung Saugplatte
9	Vakuumpumpen	21	Ladebuchse
10	Saugplatte (nicht im Lieferumfang)	22	Haltegriff
11	Akku	23	Gerätedeckel

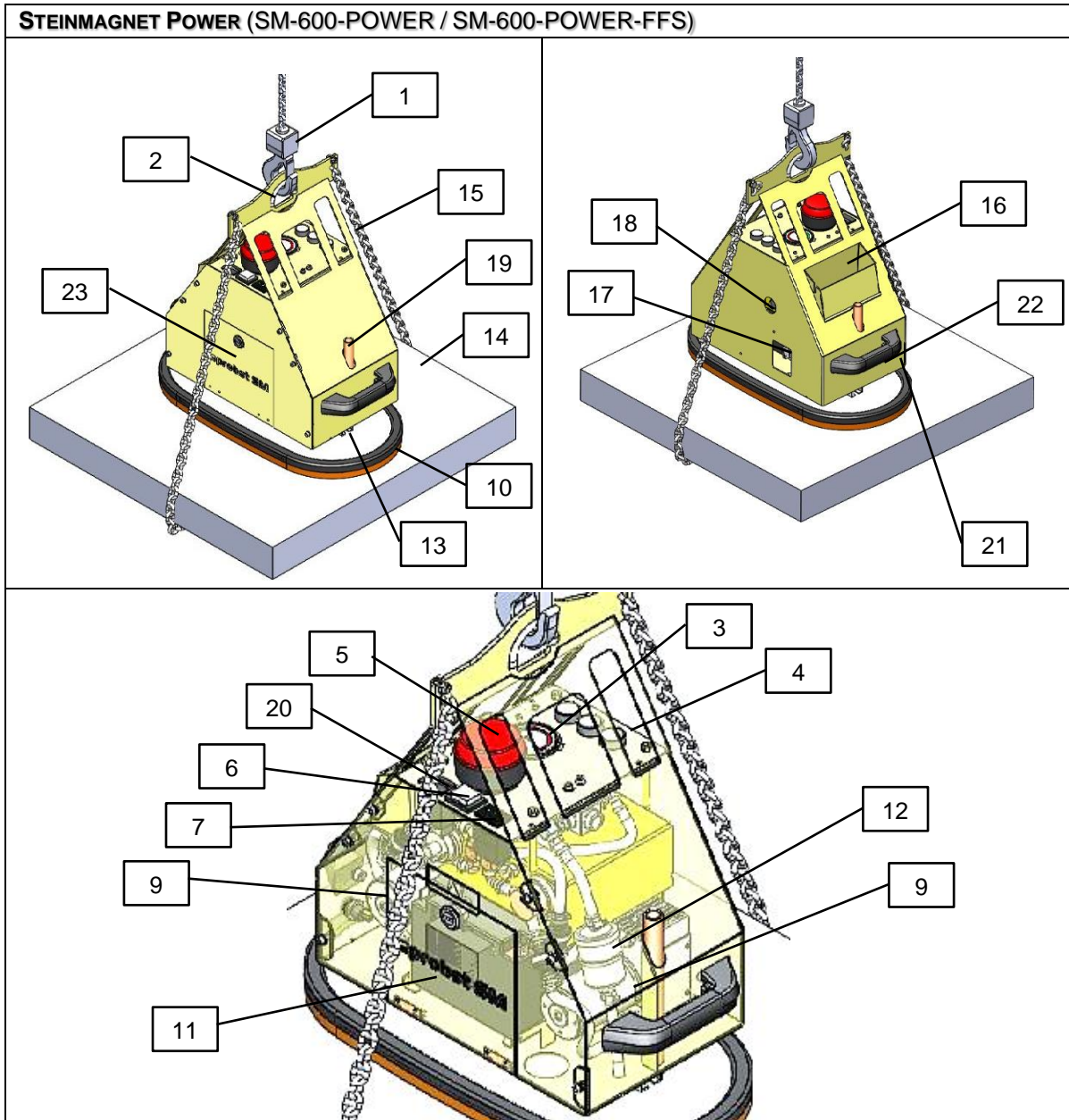
STEINMAGNET POWER (SM-600-POWER / SM-600-POWER-FFS)



Pos.	Beschreibung	Pos.	Beschreibung
1	Kranhaken (nicht im Lieferumfang)	13	C-Schiene der Saugplatte (nicht im Lieferumfang)
2	Aufhängung	14	Last (Steinplatte)
3	Vakuummanometer	15	Lastsicherungskette
4	Bedientaster	16	Kettenkasten
5	Rote Blitzleuchte	17	Ablass-Ventil
6	Ein-/Ausshalter (mit 3 Stellungen)	18	Schauglas
7	Ladezustandsanzeige Akku	19	Befestigungsbohrung Saugplatte
8	Gehäuse mit Sicherheitsspeicher	20	Betriebsstundenzähler
9	Vakuumpumpen	21	Ladebuchse
10	Saugplatte (nicht im Lieferumfang)	22	Haltegriff
11	Akku	23	Gerätedeckel
12	Schmutzfilter		

2.2 Bedienelemente

Steinmagnet Standard SM-600-POWER	Steinmagnet Power SM-600-POWER SM-600- POWER-FFS
---------------------------------------------	-----------------------------------------------------------------

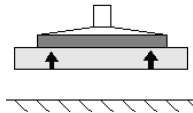

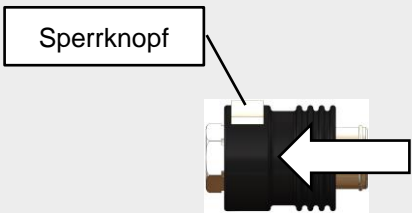
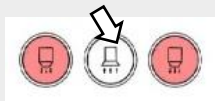
Last ansaugen

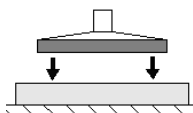

 <p>Sperrknopf</p>		<p>Option Funkfernsteuerung</p> 
<p>Zum Verschieben des Handschiebeventils, gleichzeitig Sperrknopf drücken !</p>		

Last lösen

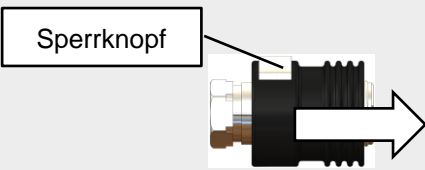

 <p>Sperrknopf</p>		<p>Option Funkfernsteuerung</p> 
<p>Zum Verschieben des Handschiebeventils, gleichzeitig Sperrknopf drücken !</p>		<p>Zum Lösen beide Taster gleichzeitig drücken.</p>

2.3 Typenschild



Das Typenschild dient zur Identifikation des Gerätes. Die Angaben auf dem Typenschild sind bei Ersatzteilbestellungen, Gewährleistungsansprüchen und sonstigen Anfragen zum Gerät stets anzugeben. Das Typenschild ist an der Außenseite des Hebeegerätes angebracht und fest mit diesem verbunden.

Auf dem Typenschild sind folgende Daten verzeichnet:

- Gerätetyp
- Artikelnummer
- Auftragsnummer
- Seriennummer
- Baujahr
- Eigengewicht
- Tragfähigkeit
- Spannung

2.4 Vakuumerzeuger

Zur Vakuumerzeugung können mit Hilfe des Ein-/Ausschalters eine oder zwei Vakuumpumpen eingeschaltet werden.

1 Vakuumpumpe: Höhere Akku-Standzeit

2 Vakuumpumpen: Kürzere Ansaugzeit und höherer Luftdurchsatz

Sinkt der Unterdruck auf $-0,53$ bar ab, schalten die Vakuumpumpen automatisch ein und bringen den Unterdruck wieder auf $-0,66$ bar.

2.5 Saugplatten

Die Saugplatten (nicht im Lieferumfang enthalten) dienen zum Ansaugen der Last (siehe auch Kap. 5.3). Nur Gegenstände mit ebener, dichter Oberfläche sind für das Heben mit diesem Gerät geeignet.

2.6 Sicherheitseinrichtungen

Das Hebeegerät verfügt über folgende Sicherheitseinrichtungen

- ⇒ Rote Blitzleuchte (überwacht das Betriebsvakuum und Energieausfall)
- ⇒ Vakuumschalter
- ⇒ Manometer mit roter Gefahrenbereichsanzeige
- ⇒ 1 Vakuumspeicher
- ⇒ Lastsicherungskette

Sicherheitseinrichtungen prüfen (Wartungsintervalle siehe Kap.9.2).

3 Technische Daten

	Standard SM-600	Power SM-600-POWER /-POWER- FFS
Max. Traglast*	600 kg	
Eigengewicht (ohne Saugplatte)	ca. 34 kg	ca. 35 kg
Volumen Sicherheitsspeicher	ca. 2,5 l	
Saugleistung der Vakuumpumpe		
Schalterstellung 1 (1 Pumpe läuft)	29 l/min	52 l/min
Schalterstellung 2 (2 Pumpen laufen)	58 l/min	104 l/min
Max. Enddruck	500 mbar Vakuum	
Temperatur-Einsatzbereich	+3 °C bis 40 °C	
Spannung	12 V DC	
Stromaufnahme		
Schalterstellung 1 (1 Pumpe läuft)	3,8 A	4,5 A
Schalterstellung 2 (2 Pumpen laufen)	7,6 A	9,0 A
Fördermedium	Umgebungsluft	



*) Die maximale Traglast des Hebeegerätes ist abhängig von der Saugplatte (nicht im Lieferumfang enthalten, siehe auch Kap. 5.3)

 GEFAHR	
	<p style="text-align: center;">Unfallgefahr durch Überschreitung der Traglast</p> <p>▶ Die zulässige Traglast des Transport- oder Hubmittels (z.B. Kran, Kettenzug, Baustellenfahrzeug, ...) und des Hebezeugs muss mindestens so groß sein, wie das Eigengewicht und die Traglast des Hebeegerätes zusammen!</p>

3.1 Technische Daten der Funkfernsteuerung (nur SM-600-POWER-FFS)

	Power SM-600-POWER-FFS
Frequenzband	2405-2480 MHz
Anzahl Kanäle	16 (Kanal 11-26)
IP-Code	67
Betriebstemperatur	-20 – +55 °C / -4 – +130 °F

4 Anlieferung, Verpackung und Transport

4.1 Anlieferung

4.1.1 Lieferumfang

Den genauen Lieferumfang entnehmen Sie der Auftragsbestätigung. Die Gewichte und Abmessungen sind in den Lieferpapieren aufgelistet.



Die Betriebs- und Wartungsanleitung ist Bestandteil des Hebegeräts und bei jedem Standortwechsel beizulegen.

4.1.2 Vollständigkeit prüfen

Die gesamte Sendung anhand beiliegender Lieferpapiere auf Vollständigkeit prüfen!

4.1.3 Schäden melden

Nach Anlieferung der Sendung sind Schäden infolge mangelhafter Verpackung oder durch den Transport sofort dem Spediteur und der Probst GmbH zu melden.





4.2 Verpackung

Das Hebegerät wird auf einer Palette verpackt ausgeliefert.



Das Verpackungsmaterial ist gemäß den landesspezifischen Gesetzen und Richtlinien zu entsorgen. Gekennzeichnete Transporthilfen und Sicherungen müssen entfernt werden.

4.3 Transport



 WARNUNG	
  	<p>Verletzungsgefahr durch unsachgemäßes Transportieren und Personen- und Sachschäden sind die Folge.</p> <ul style="list-style-type: none"> ▶ Nur Personal welches sicherheitstechnisch und an Flurförderfahrzeugen ausgebildet ist darf abladen und transportieren ▶ Benutzen Sie ausreichend dimensionierte Hebezeuge und ▶ Transportgüter müssen entsprechend den landespezifischen Vorgaben gesichert sein (BAG-Richtlinien in Deutschland). ▶ Persönliche Schutzausrüstung

4.4 Entnahme Hebegeräts von der Palette

Die Verpackung ist vorsichtig zu öffnen!

Bei der Verwendung von Messern oder Klingen zum Öffnen der Verpackung ist darauf zu achten, dass keine Bauteile beschädigt werden.

Entnehmen Sie nun vorsichtig das Hebegerät!

 VORSICHT	
 	<p>Schwere Bauteile auf der Palette Beim Öffnen der Verpackung können Teile verrutscht sein und herunterfallen. Dies kann zu Quetschungen, Schnittverletzungen führen</p> <p>▶ Tragen Sie Sicherheitsschuhe (S1), Arbeitshandschuhe (Sicherheitskategorie 2133)!</p>

ACHTUNG	
	<p>Unsachgemäßes Entnehmen des Systems aus der Transportkiste Beschädigung des Systems</p> <p>▶ Keine Gewalt anwenden</p> <p>▶ Hinweise zur Entnahme des Systems aus der Transportkiste beachten.</p>

5 Inbetriebnahme





Vor der ersten Inbetriebnahme müssen die nachfolgend beschriebenen Bedienschritte von einer qualifizierten Fachkraft überprüft und das Kapitel 1.10 (Anforderungen und Hinweise an das Installations-, Wartungs- und Bedienpersonal) gelesen werden.

5.1 Werkzeugliste





Zur Installation wird kein Werkzeug benötigt.

5.2 Hebegerät anschlagen

 WARNUNG	
 	<p>Abreißgefahr durch fehlerhafte Montage</p> <p>Personen werden durch herabstürzende Teile verletzt oder erschlagen!</p> <ul style="list-style-type: none"> ▶ Das Hebegerät darf nur an der Einhängeöse angeschlagen werden! ▶ Die zulässige Traglast des Transport- oder Hubmittels (z.B. Kran, Kettenzug, Baustellenfahrzeug, ...) und des Hebezeugs muss mindestens so groß sein, wie das Eigengewicht und die Traglast des Hebegerätes zusammen! ▶ Das verwendete Transport- oder Hubmittel und das Hebezeug müssen sich in einwandfreiem Zustand befinden!

5.3 Montage der Saugplatte am Hebegerät

Die Saugplatte und das Befestigungsmaterial ist nicht im Lieferumfang enthalten.

 GEFAHR	
	<p>Unfallgefahr durch versehentliches Einschalten.</p> <ul style="list-style-type: none"> ▶ Hebegerät vor Montage der Saugplatte ausschalten !
 GEFAHR	
	<p>Unfallgefahr durch ungeeignetes Befestigungsmaterial.</p> <ul style="list-style-type: none"> ▶ Die Saugplatte ist kundenseitig auszulegen in Abhängigkeit von der Last (Oberfläche, Dichtheit, Gewicht). Der Kunde verpflichtet sich, die statische Festigkeit und die Haltekräfte in Abhängigkeit vom erreichbaren Vakuum nachzuweisen sowie die Sicherheitsfaktoren einzuhalten. Hierbei ist die Norm DIN EN 13155 in ihrer zur Zeit der Montage gültigen Fassung als Grundlage zu nehmen. ▶ Die Saugplatte muss mit geeignetem Befestigungsmaterial montiert werden. <ul style="list-style-type: none"> • 2 Gewindestangen M12 – 4.6, Länge 247 mm • 2 Ringmuttern DIN 582 E – M12 – C15 verzinkt

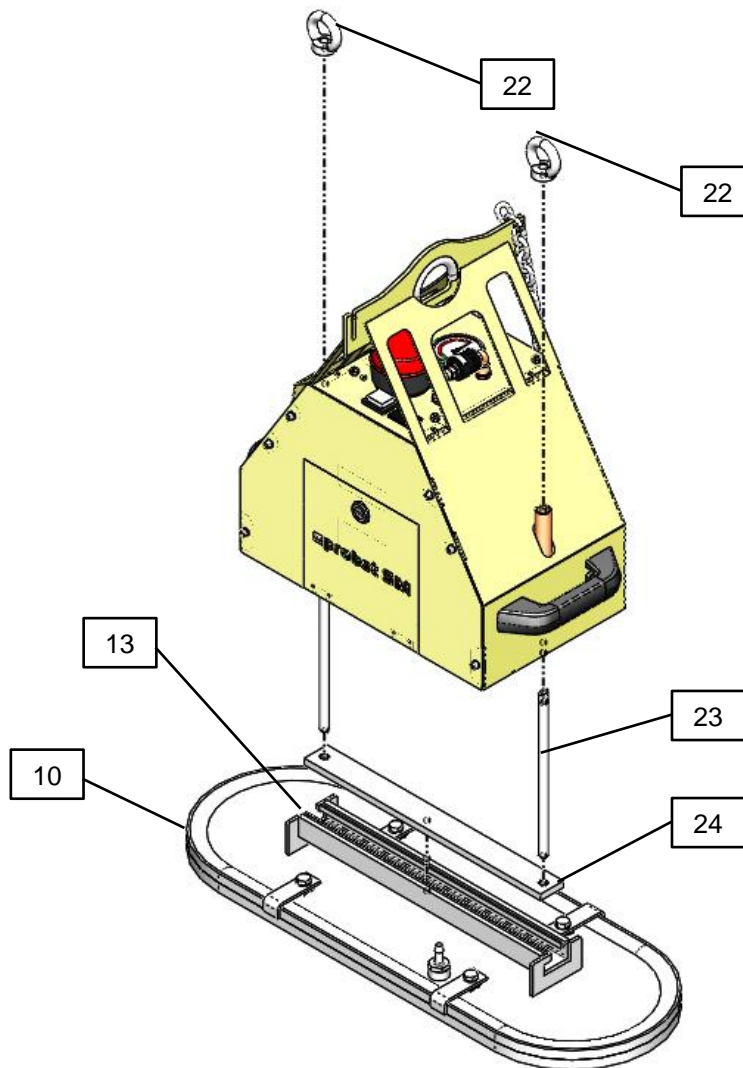

Befestigungsmaterial Saugplatte (nicht im Lieferumfang enthalten):

Pos.	Beschreibung	Pos.	Beschreibung
10	Saugplatte	23	Gewindestange
13	C-Schiene	24	Nutenstein
22	Ringmutter		

1. Beide Gewindestangen so in die Nutensteine schrauben, dass das Gewinde vollständig eingeschraubt ist.
2. Beide Gewindestangen von unten in die zwei Befestigungsbohrungen des Gehäuses soweit einführen, bis die Gewindestangen oben aus dem Gehäuse herausragen.
3. Ringmutter 2-3 Gewindegänge auf die Gewindestangen locker aufschrauben.
4. C-Schiene der Saugplatte von der Seite über den Nutenstein schieben.
5. Saugplatte zentral positionieren.
6. Ringmuttern fest anziehen und prüfen ob Saugplatte fest sitzt.
7. Vakuumschlauch der Saugplatte anschließen.
8. Dichtheit prüfen (siehe Kap. 0).
- 9. Vor der Arbeit mit Lasten alle Sicherheitseinrichtungen prüfen.**



Die Installation des Hebeegeräts ist abgeschlossen, sobald mindestens 3-4 Testläufe mit einer Last erfolgreich durchgeführt wurden. Die in Europa nach der DIN EN 13155 erforderlichen Prüfungen vor Inbetriebnahme sind durch eine Bauartprüfung abgedeckt.

5.4 Wechseln der Saugplatte

1. Hebeegerät auf einer sauberen, ebenen Fläche abstellen.
2. Hebeegerät ausschalten.
3. Vakuumschlauch abziehen.
4. Ringmuttern lösen.
5. Hebeegerät anheben, dabei Saugplatte festhalten.
6. Neue Saugplatte am Hebeegerät befestigen (siehe Kap. 5.3).
7. Ungenutzte Saugplatte an einem geeigneten Ort lagern (siehe Kap. 7).

5.5 Energieversorgung

Das Hebeegerät wird von einem integrierten Akku gespeist. Eine externe Energieversorgung während des Betriebs ist nicht erforderlich.



Eine Akku-Ladung hält etwa einen Arbeitstag.

Um das Hebeegerät jederzeit betriebsbereit zu halten, muss der Akku nach jedem Arbeitseinsatz aufgeladen werden.

Der Akku kann permanent geladen werden.

Zusätzlich kann ein Ersatzakku bereitgehalten werden (Hinweise zum Austausch des Akkus siehe Kap. 9.2).





6 Betrieb



Hinweis zur Vermietung/Verleihung:

Bei jeder Verleihung/Vermietung des Hebeegerätes muss unbedingt die dazu gehörige Original Betriebsanleitung mitgeliefert werden (bei Abweichung der Sprache des jeweiligen Benutzerlandes, ist zusätzlich die jeweilige Übersetzung der Original-Betriebsanleitung mitzuliefern)!

6.1 Allgemeine Sicherheitshinweise zum Betrieb

 WARNUNG	
	<p>Missachtung der allgemeinen Sicherheitshinweise zum laufenden Schaden an Personen und System sind die Folge.</p> <p>System ausschließlich nur durch geschultes Personal betreiben, welches die Betriebs- und Wartungsanleitung gelesen und verstanden hat.</p>
 WARNUNG	
	<p>Verletzungsgefahr durch hohen Unterdruck und hohen Haare, Haut, Körperteile und Kleidungsstücke werden angesaugt.</p> <ul style="list-style-type: none"> ▶ Eng anliegende Kleidung tragen, Haarnetz verwenden. ▶ Nicht in den Sauganschluss hineinsehen. ▶ Nicht in den Sauganschluss hineinfassen. ▶ Nicht in die Nähe von Körperöffnungen bringen



WARNUNG



Verbot

Gefahr durch herabfallende Gegenstände

- **wenn der Unterdruck zusammenbricht**
- **wenn die Last durch Kollision abschert**
- **wenn Bauteile durch Überbelastung oder unzulässige Umbauten versagen**

Personen werden getroffen und verletzt oder erschlagen!

- ▶ Es darf sich keine Person im Gefahrenbereich der Last aufhalten.
- ▶ Last nie über Personen hinweg befördern.
- ▶ Vor dem Transport muss eine entsprechende Schutzausrüstung angelegt werden.
- ▶ Nur bei freier Sicht über den ganzen Arbeitsbereich arbeiten.
- ▶ Auf andere Personen im Arbeitsbereich achten!
- ▶ Haltegriff des Hebeegeräts nicht loslassen, solange eine Last gehoben
- ▶ Lasten niemals schräg ziehen, schleppen oder schleifen.
- ▶ Niemals festsitzende Lasten mit dem Hebegerät losreißen.
- ▶ Nur geeignete Lasten ansaugen und heben (Eigenstabilität und Porosität durch Versuche prüfen).
- ▶ Der Benutzer/Betreiber muss den Arbeitsbereich absichern. Die dafür notwendigen Personen bzw. Einrichtungen sind während des Hebe-/Transportvorgangs bereitzustellen.
- ▶ Die zulässige Traglast je Saugplatte darf nicht überschritten werden.
- ▶ Keine Teile auf dem Hebegerät abstellen.
- ▶ Während der Handhabung darf das Vakuum nicht abgeschaltet werden.
- ▶ **Last nur mit angelegter Lastsicherungskette anheben und transportieren!**
- ▶ **Das Arbeiten mit diesem Gerät darf nur in bodennahem Bereich erfolgen.**
Die angesaugte Last **muss** unmittelbar nach dem Aufnehmen (z.B. von einer Palette oder von einem LKW) bis knapp über den **Boden abgesenkt werden** (ca. 20 - 30 cm). Anschließend ist die **Last durch die Lastsicherungskette zusichern** und darf **erst dann** zur Verlegestelle transportiert werden.
Last zum Transportieren nur so hoch wie nötig anheben (Empfehlung ca. 0,5 m über Boden).
- ▶ **Das Schwenken des Gerätes über Personen hinweg ist untersagt. Lebensgefahr!**

6.2 Prüfungen vor Arbeitsantritt

 WARNUNG	
	<p>Gefahr durch herabfallende Gegenstände.</p> <ul style="list-style-type: none"> ▶ 1. Ladezustand des Akkus prüfen (Anzeige Pos. 7, zum Austausch des Akkus siehe Kap. 9.2). <ul style="list-style-type: none"> • Der Akku ist voll, wenn die Ladezustandsanzeige in den ersten 10 Sekunden nach dem Einschalten auf GRÜN steht. • Nach 10 Sekunden kann die Ladezustandsanzeige auf GELB schalten. • Das Hebegerät kann verwendet werden • Akku vor der Verwendung aufladen, wenn die Ladezustands-anzeigedirekt beim Einschalten auf GELB oder ROT steht. • Eine Akku-Ladung hält etwa einen Arbeitstag. • Um das Hebegerät jederzeit betriebsbereit zu halten, muss der Akku nach jedem Arbeitseinsatz aufgeladen werden. • Der Akku kann permanent geladen werden. 2. Zustand der Saugplatte prüfen. 3. Sicherstellen, dass die Saugplatte sicher befestigt ist. 4. Sicherheitseinrichtungen prüfen (siehe Kap. 2.6). 5. Schmutzfilter prüfen und ggf. austauschen. 6. Kondenswasser prüfen und ggf. ablassen (siehe Kap. 0). 7. Sicherstellen, dass die verwendeten Transport- oder Hubmittel (z.B. Kran, Kettenzug, Baustellenfahrzeug, ...) und das Hebezeug geeignet sind (max. Traglast siehe Kap. 3).

6.3 Verhalten im Notfall

Ein Notfall liegt vor:

- bei Ausfall der Vakuumzufuhr (z. B. bei Energieausfall → Vakuumerzeugung schaltet aus). Ein eingebauter Speicher hält den Unterdruck in diesem Fall noch für eine kurze Sicherheitszeit aufrecht (abhängig von der Dichtheit der Lastoberfläche).
- bei Eintritt einer Leckage (z. B. Schlauchabriss)
- durch auftretende Kräfte bei einer Kollision
- wenn während der Handhabung der Last das Vakuumniveau unter -0,6 bar in den roten Bereich des Manometers abfällt.

 WARNUNG	
	<p>Verletzungsgefahr durch Abfall des Vakuumniveaus bei Energieausfall bzw. Ausfall der Vakuumerzeugung</p> <p>Personen werden sich quetschen und verletzen.</p> <ul style="list-style-type: none"> ▶ Der Bediener hat im Falle einer Gefährdung unverzüglich Alarm zu ▶ Niemals in den Gefahrenbereich treten. ▶ Wenn möglich die Last sicher abstellen.

6.4 Option Funkfernsteuerung

Die Funkfernsteuerung wurde überprüft und entspricht den Grenzwerten für ein digitales Gerät der Klasse B gemäß Teil 15 der FCC-Bestimmungen. Diese Grenzwerte sollen einen angemessenen Schutz vor schädlichen Interferenzen in Wohngebieten gewährleisten.

Die Funkfernsteuerung erzeugt, verwendet und strahlt Hochfrequenzwellen aus, die zu Störungen des Funkverkehrs führen können, wenn sie nicht in Übereinstimmung mit den Anweisungen verwendet wird.

Es gibt jedoch keine Garantie dafür, dass in einer bestimmten Installation keine Interferenz auftritt. Falls die Funkfernsteuerung Interferenzen bei Radio- oder TV-Empfang auslöst, was durch Ab- und Anschalten der Funkfernsteuerung festgestellt werden kann, wird empfohlen, die Interferenz durch eine oder mehrere der folgenden Maßnahmen zu beheben:

- Empfängerantenne neu ausrichten oder neu positionieren.
- Abstand zwischen Funkfernsteuerung und Empfänger vergrößern.
- Händler oder erfahrenen Radio-/TV-Spezialisten konsultieren.

 VORSICHT	
	<p>Verletzungsgefahr durch unkontrollierte Bewegung des Hebeapparates</p> <ul style="list-style-type: none"> ▶ Transportweg und Last immer im Auge behalten ! Nur bei guter Sicht über den ganzen Arbeitsbereich arbeiten. ▶ Vor dem Ablösen der Last sicherstellen, dass keine Person im Gefahrenbereich ist.

6.5 Last anheben – Ansaugen

 WARNUNG	
	<p>Verletzungsgefahr durch herabfallende Last</p> <ul style="list-style-type: none"> ▶ Vor jedem Transportvorgang Last mit Hilfe der Lastsicherungskette sichern. ▶ Last erst ab einem Vakuumwert von -0,6 bar (Manometernadel im grünen Bereich) anheben. Die Haltekraft ist sonst nicht ausreichend. ▶ Last niemals ruckartiges anheben oder absenken. ▶ Lasten mit feuchten, nassen, öligen, vereisten, verschmutzten, staubigen oder andersartig die Reibung herabsetzenden Oberflächen müssen vor dem Ansaugen gereinigt werden ! ▶ Max. Traglast der Saugplatte darf nicht überschritten werden.

WARNUNG	
	<p>Verletzungsgefahr durch unkontrollierte Bewegung des Hebegerätes</p> <ul style="list-style-type: none"> ▶ Last immer im Schwerpunkt greifen ▶ Last muss lose sein. ▶ Last darf nirgends anhaften. ▶ Last darf nicht verkantet sein.

Last ansaugen

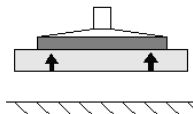

Steinmagnet Standard SM-600	Steinmagnet Power SM-600-POWER SM-600-POWER-FFS	
<p>Zum Verschieben des Handschiebeventils, gleichzeitig Sperrknopf drücken !</p>		<p>Option Funkfernsteuerung</p>

1. Hebegerät im Schwerpunkt der Last positionieren.
2. Sicherstellen, dass die gesamte Fläche der Saugplatte auf der Last aufsitzt.
3. Last mit Hilfe der Lastsicherungskette sichern:
 - angesaugte Last ca. 20-30 cm anheben
 - Lastsicherungskette unter der Last durchführen (durchwerfen)
 - **Gefahr: dabei NIEMALS unter die Last (Steinplatte) mit den Händen fassen → Quetschgefahr!!!**
 - Lastsicherungskette auf der anderen Seite des Gerätes einhängen
 - die Lastsicherungskette **muss straff** an der Last anliegen (siehe nachfolgende Abbildung), damit diese bei Vakuumverlust durch die Lastsicherungskette gehalten wird.
 - die Lastsicherungskette **darf niemals locker** unter der Last hängen, da sonst Last bei Vakuumausfall/Verlust (z.B. bedingt durch Energieausfall) **herunterfallen kann. → Unfallgefahr!!!**
4. Schrägziehen vermeiden.
5. Energieversorgung einschalten.
→ Blitzleuchte in Betrieb, bis der Unterdruck -0,6 bar erreicht ist.
6. Bedienelement betätigen (siehe Abb. oben je nach Modell).
7. Manometer beobachten. Sobald -0,6 bar Unterdruck erreicht ist (Manometernadel im grünen Bereich), Last anheben.

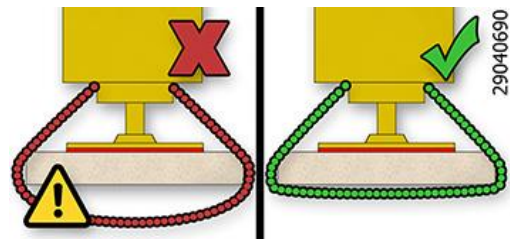

6.6 Last führen

 WARNUNG	
	<p>Verletzungsgefahr durch unkontrollierte Bewegung des Hebe Gerätes</p> <ul style="list-style-type: none"> ▶ Zum Führen der Last Haltegriff verwenden. Sicherheitsabstände einhalten. ▶ Transportweg und Last immer im Auge behalten ! Nicht vor der Last gehen! Stolpergefahr! Beim Abstoppen der horizontalen Fahrbewegung pendelt die Last in Fahrtrichtung. ▶ Lasten immer so bodennah wie möglich transportieren und die Transportgeschwindigkeit den Gegebenheiten anpassen. ▶ Ruckartiges Verfahren des Hebe Gerätes ist untersagt, da das Hebegerät in Dreh- und Pendelbewegungen geraten kann.

WARNUNG	
	<p>Verletzungsgefahr durch herabfallende Last</p> <ul style="list-style-type: none"> ▶ Niemals das Hebegerät mit angesaugter Last schnell über unebenes Gelände verfahren.

6.7 Last ablegen – Lösen

WARNUNG	
 	<p>Verletzungsgefahr durch kippende Teile</p> <ul style="list-style-type: none"> ▶ Last vorsichtig absenken (ca. 20-30 cm Abstand zum Boden), Lastsicherungskette aushängen und unter Last hervorziehen. Niemals dabei unter die Last (Steinplatte) mit den Händen fassen! Quetschgefahr!!! Lastsicherungskette wieder in den Kettenkasten legen. Die Last muss sicher auf dem Boden oder in einer geeigneten Abstellvorrichtung stehen, bevor sie vom Hebegerät gelöst wird. ▶ Ggf. muss die Last gegen Verrutschen oder Kippen gesichert werden, bevor sie vom Hebegerät gelöst wird. ▶ Sobald die Last durch die Lastsicherungskette aufgefangen wurde, muss die Lastsicherungskette fachgerecht geprüft und bei Bedarf ersetzt werden. Beschädigte Lastsicherungsketten dürfen nicht weiter eingesetzt werden!!!

Last lösen

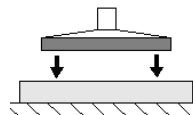

Steinmagnet Standard SM-600	Steinmagnet Power SM-600-POWER SM-600-POWER-FFS	
		<p>Option Funkfernsteuerung</p>

**Zum Verschieben des Handschiebeventils,
gleichzeitig Sperrknopf drücken !**

**Zum Lösen beide Taster gleichzeitig
drücken.**

1. Last absenken und sicher auf freie, ebene Fläche ablegen,
2. Sicherstellen, dass die Last nicht abrutschen oder kippen kann.
3. Zum Absetzen Bedienelement betätigen (siehe Abb. oben je nach Modell)

Die Last löst sich. Das Hebegerät kann wieder angehoben werden.

6.8 Hebegerät parken

Das kurzzeitige Abstellen des Hebegeräts im ausgeschalteten Zustand wird als „Parken“ bezeichnet.

Vorgehen:

1. Energiezufuhr abstellen.
2. Ggf. Kondenswasser ablassen (siehe Kap. 0).
3. Hebegerät in einer sicheren Position am Transport- oder Hubmittel hängen lassen (nicht auf der Last absetzen!).

7 Lagerung

Möglichkeiten der korrekten Lagerung bei Nichtbenutzung:

- Hebegerät hängen lassen oder
- Hebegerät stehend einlagern,
WICHTIG ! Vor dem Abstellen Saugplatte abmontieren und gesondert lagern.

ACHTUNG	
	<p>Beschädigung des Sauggreifers</p> <p>Sauger werden deformiert, altern vorzeitig und fallen aus.</p> <p>▶ Lagerung der Sauger und Sauggreifer nach Lagerempfehlung für Elastomer teile.</p>

Lagerempfehlung für Elastomer teile

Einwirkungen von Ozon, Licht (besonders UV), Wärme, Sauerstoff, Feuchtigkeit und mechanische Einwirkungen können die Lebensdauer von Gummierzeugnissen verkürzen. Lagern Sie die Gummiteile daher kühl (0 °C bis + 15 °C, max. jedoch 25 °C, dunkel, trocken, staub arm, witterungs-, ozon- und zugluftgeschützt sowie spannungsfrei (z. B. geeignetes Stapeln ohne Verformung).

Sicherstellen, dass kein Kondenswasser im Speicher ist (Schauglas Pos. 18). Ggf. Kondenswasser ablassen (siehe Kap. 0).

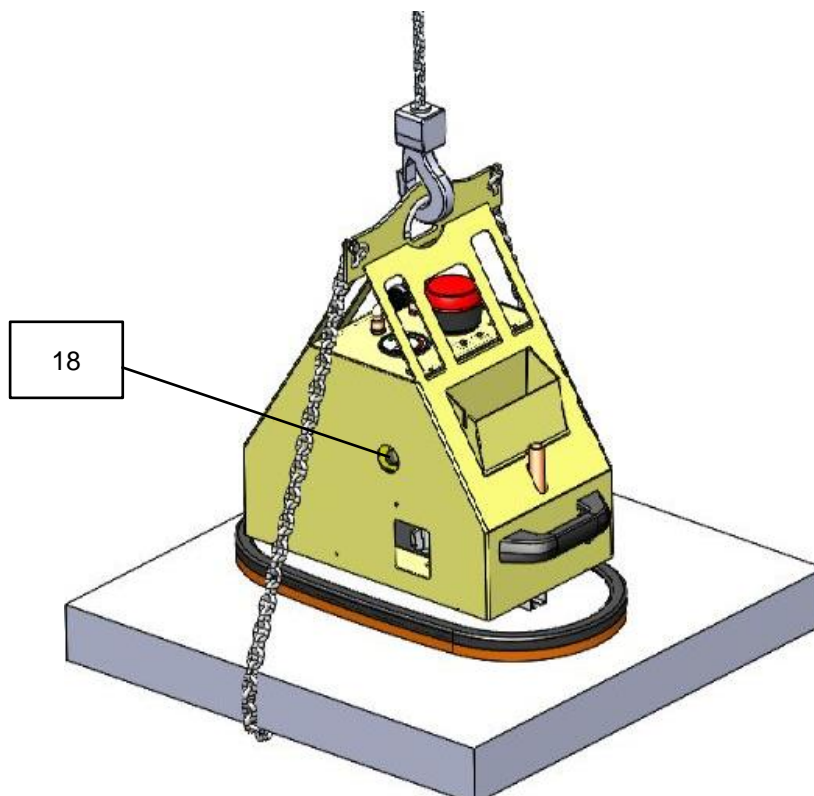

8 Störungsbehebung

Das Hebegerät darf nur von qualifizierten Fachkräften und Mechanikern installiert, gewartet und repariert werden. Siehe Kapitel 1.10 Pflichten des Betreibers.



Prüfen Sie nach Reparatur- oder Wartungsarbeiten auf jeden Fall die Sicherheitseinrichtungen wie in Kapitel "9.5 Sicherheitseinrichtungen prüfen" beschrieben.



Wenn die **Last nicht gehoben werden kann**, gehen Sie die folgende Liste durch, um den Fehler zu finden und zu beheben.



Fehler	Ursache	Abhilfe
Vakuumerzeugung arbeitet nicht	Akku leer oder defekt	Akku laden oder austauschen (siehe Kap. 9.2)
	Steckverbinder am Akku nicht angeschlossen	Steckverbinder anschließen
Vakuumerzeugung arbeitet, Unterdruck von -0,6 bar wird nicht erreicht	Dichtlippe der Saugplatte ist beschädigt	Saugplatte tauschen
	Last hat Risse, Aussparungen oder ist porös	Handhaben der Last mit diesem Hebegerät nicht möglich
	Manometer ist defekt	Manometer tauschen
	Schlauch / Verschraubungen undicht	Bauteile austauschen / abdichten
	Vakuumschalter verstellt / defekt	Kundendienst anrufen
	Filter ist verschmutzt	Filter ausblasen oder austauschen
	Filter nicht verschlossen	Filter verschließen
	Schlauch / Verschraubungen undicht	Bauteile austauschen / abdichten
Vakuumerzeugung arbeitet, saugt aber nicht	Ein-/Ausschalter auf Pos. „I“ (nur eine Vakuumpumpe läuft)	Ein-/Ausschalter auf Pos. „II“ schalten (zwei Vakuumpumpen laufen)
	Handschiebeventil ist in Position "Lösen"	Handschiebeventil in Position "Last ansaugen" schieben
Blitzleuchte blinkt, Unterdruck fällt ab unter -0,48 bar	Handschiebeventil defekt	Kundendienst anrufen
	Last hat Risse, Aussparungen oder ist porös	Handhaben der Last mit diesem Hebegerät nicht möglich
	Dichtlippe ist beschädigt	Saugplatte austauschen
	Schlauch defekt / Verschraubungen undicht	Bauteile austauschen
	Vakuumschalter verstellt / defekt	Kundendienst anrufen

9 Wartung

9.1 Allgemeine Hinweise

Das Hebegerät darf nur von qualifizierten Fachkräften und Mechanikern installiert, gewartet und repariert werden. Siehe Kapitel 1.10 Pflichten des Betreibers.

 WARNUNG	
	<p>Unfallgefahr bei Wartung des Systems durch ungeschultes Personal Schwere Personenschäden sind die Folge</p> <p>► System ausschließlich durch geschultes Personal warten, welches die Betriebs- und Wartungsanleitung gelesen und verstanden hat.</p>

 WARNUNG	
	<p>Unfallgefahr durch verschlissene und nicht gewartete Teile Durch verschlissene und nicht gewartete Teile können Schäden auftreten, die zum Ausfall des Hebegeräts als auch zu schwersten Unfällen führen können.</p> <p>► Halten Sie die in dieser Betriebs- und Wartungsanleitung vorgeschriebenen Betriebs-, Wartungs- und Instandhaltungsbedingungen ein.</p>

9.2 Akku austauschen

Wenn die Standzeit des Akkus nachlässt, muss er ausgetauscht werden.

Vorgehen:

1. Gerät ausschalten.
2. Gerätedeckel öffnen (mit großem Schlitzschraubendreher).
3. Verbindungsstecker lösen.
4. Akku entnehmen.
5. Polkabel am neuen Akku befestigen.
Dabei auf die richtige Polung achten:
ROT = PLUSPOL
SCHWARZ = MINUSPOL
6. Akku einsetzen.
7. Verbindungsstecker anschließen.
8. Gerätedeckel schließen und mit Schraubendreher verriegeln.
9. Verbrauchten Akku fachgerecht entsorgen.



9.3 Vakuumerzeuger

Siehe beiliegende Bedienungsanleitung der Vakuumpumpe / (Anhang).

9.4 Saugplatten / Dichtlippen

- Dichtlippen mindestens einmal wöchentlich von anhaftenden Gegenständen und Schmutz wie Sand, Steinpartikel u. Staub usw. reinigen.
- Schwammgummi mit Druckluft und/oder Wasserstrahl oder Seifenwasser reinigen.
- Beschädigte oder verschlissene Saugplatten (Risse, Löcher, Wellenbildung) sofort austauschen.
- Saugplatten immer komplett austauschen !



Tipp:
Durch Erwärmung lässt sich die Verschraubung der Saugplatte besser lösen!

Anschluss der Saugplatte beim Einschrauben wieder abdichten!

9.5 Sicherheitseinrichtungen prüfen

Prüfen Sie die Sicherheitseinrichtungen (siehe Kap. 2.6) zu Beginn jeder Arbeitsschicht (bei unterbrochenem Betrieb) oder einmal wöchentlich (bei durchgehendem Betrieb).

9.5.1 Blitzleuchte prüfen

Vakuumerzeugung einschalten.

Hebegerät auf eine Last mit dichter, glatter Oberfläche aufsetzen und Last ansaugen.

 WARNUNG	
	<p>Verletzungsgefahr durch herabfallende Last , wenn der Unterdruck zusammenbricht</p> <p>Last kann sich bei der Überprüfung lösen und abfallen.</p> <p>▶ Last nur ansaugen, nicht anheben.</p>

Wenn der Unterdruck aufgebaut ist, Dichtlippe der Saugplatte leicht anheben, um eine Undichtheit zu simulieren. Der Unterdruck am Manometer nimmt ab. Wenn der Unterdruck unter -0,43 bar sinkt, leuchtet die Blitzleuchte auf.

 WARNUNG	
	<p>Verletzungsgefahr durch herabfallende Last</p> <p>▶ Der Vakuumschalter ist ab Werk eingestellt und darf niemals verstellt werden.</p>

9.5.2 Saugschläuche und -klemmen prüfen

Prüfen Sie alle Saugschläuche und Schlauchklemmen auf festen Sitz, ggf. nachziehen.

9.5.3 Dichtheit prüfen

Dichtheitsprüfung monatlich durchführen.

9.5.3.1 Dichtheitsprüfung der Saugplatte

1. Gerät mit Saugplatte auf eine dichte und glatte Oberfläche (z.B. Stahlplatte) stellen.
2. Vakuum einschalten.
3. Warten bis der erforderliche Unterdruck erreicht ist (Gerät schaltet automatisch bei ca. -0,66 bar ab).
4. Angesaugte Last (Stahlplatte) etwas anheben (20-30 cm).
→ Während der Dichtheitsprüfung darf die Last **nicht herabfallen!**
Lässt der Unterdruck nach und die Vakuumpumpe kann durch Nachpumpen den erforderlichen Unterdruck wieder aufbauen, kann die Saugplatte verwendet werden!
5. Nach der Prüfung Last auf dem Boden ablegen und ablösen (Handschiebeventil →).

 WARNUNG	
	<p>Verletzungsgefahr durch herabfallende Last , wenn der Unterdruck zusammenbricht</p> <p>Last kann sich bei der Überprüfung lösen und abfallen.</p> <p>▶ Last nur 20-30 cm anheben und Füße aus dem Gefahrenbereich bringen.</p>

9.5.3.2 Dichtheitsprüfung des Gerätes (ohne Saugplatte)

1. Vakuumschlauch von Saugplatte entfernen.
2. Vakuumpumpe einschalten.
3. Öffnung des Vakuumschlauches abdichten (z.B. mit Daumen)
4. Warten bis der erforderliche Unterdruck erreicht ist (Gerät schaltet bei ca. -0,66 bar ab).
5. Vakuumpumpe ausschalten. Unterdruck darf innerhalb von **5 Minuten** um maximal um **0,1 bar** abfallen.

Beseitigen Sie Mängel, bevor Sie das Gerät in Betrieb nehmen. Stellen sich während des Betriebes Mängel ein, Gerät ausschalten und Mängel beheben.

9.6 Filter

Schmutzfilter mindestens einmal wöchentlich überprüfen. Bei starker Verschmutzung Filter austauschen.

Vorgehen:

1. Gerätedeckel öffnen.
2. Schlauchschelle lösen und Filter entnehmen.
3. Neuen Filter einsetzen und mit Schlauchschelle befestigen.
4. Gerätedeckel wieder schließen.
5. Dichtheit prüfen (siehe oben).

9.7 Kondenswasser ablassen

Bei der Vakuumerzeugung entsteht aufgrund der Luftfeuchtigkeit Kondenswasser. Das Kondenswasser muss mindestens einmal täglich abgelassen werden. Ggf. Schauglas (18) prüfen.

Vorgehen:

1. Gerät auf ebenem Grund abstellen.
2. Vakuumerzeugung ausschalten.
3. Ablassventil (Pos. 17) öffnen und Kondenswasser ablaufen lassen.
4. Ablassventil schließen.



Bei angehobener Last darf das Ablassventil (17) NICHT geöffnet werden. Ansonsten besteht Unfallgefahr durch Herabfallen der Last!

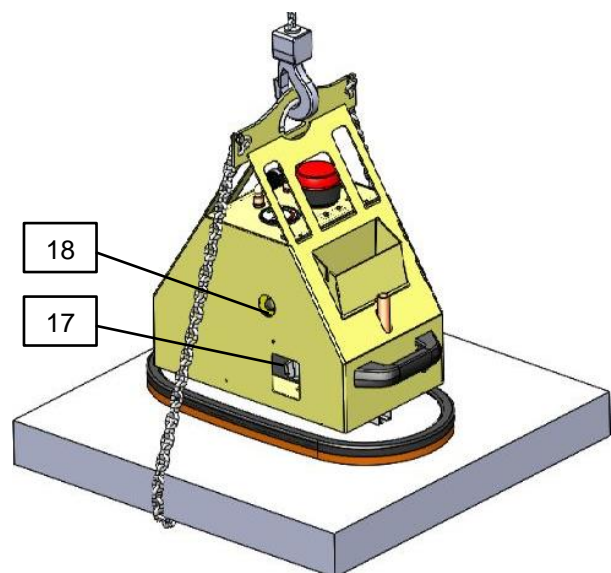
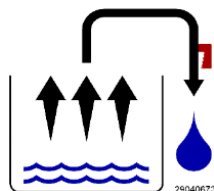

9.8 Wartungsplan

9.8.1 Mechanik



Die unten genannten Intervalle sollten bei harten Einsatzbedingungen verkürzt werden.

Intervall	Auszuführende Arbeiten
Erstinspektion nach 25 Betriebsstunden	Sämtliche Befestigungsschrauben kontrollieren bzw. nachziehen (darf nur von einem Sachkundigen durchgeführt werden).
Alle 50 Betriebsstunden	Sämtliche Befestigungsschrauben nachziehen (sicherstellen, dass die Schrauben gemäß den gültigen Anzugsdrehmomenten der zugehörigen Festigkeitsklassen nachgezogen werden). Alle Gelenke, Führungen, Bolzen und Zahnräder (wenn vorhanden) auf einwandfreie Funktion prüfen, bei Bedarf nachstellen oder ersetzen.

9.8.2 Übrige Bauelemente



Die jährliche Prüfung ist durch einen Sachkundigen durchzuführen (siehe Kap. 1)).

	Intervall				
	Täglich	Wöchent-lich	Monat-lich	1/2-jährlich	Jährlich
Sicherheitseinrichtungen prüfen: - Manometer OK? - Warneinrichtung schaltet bei korrektem Unter-/Überdruck?	X				X
Filter überprüfen, austauschen wenn erforderlich		X			X
Akku-Ladezustand prüfen (Anzeige Pos. 7)	X				X
Akku austauschen falls erforderlich					X
Sind die Vakuumschläuche in gutem Zustand (nicht brüchig, nicht geknickt, keine Scheuerstellen und damit dicht)?			X		X
Sind alle Verbindungen fest (Schlauchscheiden etc.) ?				X	X
Sind Typen-, Traglast- und Warnschilder vollständig und lesbar ?					X
Ist die Betriebs- und Wartungsanleitung noch vorhanden und den Bedienern bekannt?					X

Überprüfung tragender Teile (z.B. Aufhängung, Bolzen, Laschen ...). Prüfung auf Risse, Verformung, Verschleiß, Korrosion, Funktionssicherheit oder sonstige Beschädigungen.					X
Saugplatten reinigen / Kontrolle, keine Risse, Dichtlippe homogen etc.? Gegebenenfalls austauschen		X			X
Ist die Prüfplakette erneuert?					X
Allgemeiner Zustand des Gerätes					X
Dichtheitsprüfung			X		X
Kondenswasser ablassen		X			X
Zustand der Lastsicherungskette überprüfen 1)					X

1) Sobald die Last durch die Lastsicherungskette aufgefangen wurde, muss die Lastsicherungskette fachgerecht geprüft und bei Bedarf ersetzt werden. Beschädigte Lastsicherungsketten dürfen nicht weiter eingesetzt werden!!!

9.9 Jährliche Prüfung

- Der Unternehmer hat dafür zu sorgen, dass das Gerät mindestens jährlich durch einen Sachkundigen geprüft und festgestellte Mängel sofort beseitigt werden (→ siehe DGUV Vorschrift 1-54 und DGUV Regel 100-500).
- Die dementsprechenden gesetzlichen Bestimmungen u. die der Konformitätserklärung sind zu beachten!
- Die Durchführung der Sachkundigenprüfung kann auch durch den Hersteller Probst GmbH erfolgen. Kontaktieren Sie uns unter: service@probst-handling.com
- Wir empfehlen, nach durchgeführter Prüfung und Mängelbeseitigung des Gerätes die Prüfplakette „Sachkundigenprüfung / Expert inspection“ gut sichtbar anzubringen (Bestell-Nr.: 2904.0056+Tüv-Aufkleber mit Jahreszahl).



Die Sachkundigenprüfung ist unbedingt zu dokumentieren!

Gerät	Jahr	Datum	Sachkundiger	Firma

9.10 Reinigung

Verwenden Sie zur Reinigung des Hebeegeräts ausschließlich Kaltreiniger (Kein Waschbenzin oder ätzende Flüssigkeiten verwenden (Schläuche können dadurch undicht oder zerstört werden). Die Reinigung der Saugplatten kann mit Seife und warmem Wasser erfolgen, keinen Kaltreiniger auf den Saugerdichtlippen verwenden!

9.11 Ersatzteile

Nur für die von uns gelieferten Originalersatzteile übernehmen wir eine Gewährleistung. Für Schäden, die durch die Verwendung von nicht Original-Ersatzteilen und Zubehör entstehen, ist jegliche Haftung und Gewährleistung seitens der Probst GmbH ausgeschlossen.

Bei jeder Ersatzteilbestellung bitte Auftragsnummer, Seriennummer des Hebeegerätes sowie die Artikelnummer des Bauteils angeben (siehe Typenschild und Ersatzteilliste).

10 Außerbetriebnahme und Entsorgung

Das Hebeegerät darf nur von qualifiziertem Fachpersonal außer Betrieb genommen und zur Entsorgung vorbereitet werden.

Vorgehen:

1. Hebeegerät vom Transport- oder Hubmittel trennen.
2. Akku ausbauen und fachgerecht entsorgen (siehe Kap. 9.2).
3. Saugplatte demontieren und entsorgen.
4. Schlauchschellen lösen Schläuche abziehen.
5. Basiskörper demontieren und entsorgen.

Für die sachgerechte Entsorgung wenden Sie sich bitte an ein Entsorgungsunternehmen für technische Güter mit dem Hinweis, die zu diesem Zeitpunkt geltenden Entsorgungs- und Umweltvorschriften zu beachten. Bei der Suche nach einem geeigneten Unternehmen ist Ihnen der Hersteller des Gerätes gerne behilflich.

Wartungsnachweis



Garantieanspruch für dieses Gerät besteht nur bei Durchführung der vorgeschriebenen Wartungsarbeiten (durch eine autorisierte Fachwerkstatt)! Nach jeder erfolgten Durchführung eines Wartungsintervalls muss unverzüglich dieser Wartungsnachweis (mit Unterschrift u. Stempel) an uns übermittelt werden. ¹⁾

¹⁾ per E-Mail an: service@probst-handling.de / per Fax oder Post

Betreiber: _____
 Gerätetyp: _____ Artikel-Nr.: _____
 Geräte-Nr.: _____ Baujahr: _____

Wartungsarbeiten nach 25 Betriebsstunden		
Datum:	Art der Wartung:	Wartung durch Firma:
		Stempel
	
		Name / Unterschrift

Wartungsarbeiten nach 50 Betriebsstunden		
Datum:	Art der Wartung:	Wartung durch Firma:
		Stempel
	
		Name / Unterschrift
		Wartung durch Firma:
		Stempel
	
		Name / Unterschrift
		Wartung durch Firma:
		Stempel
	
		Name / Unterschrift

Wartungsarbeiten 1x jährlich		
Datum:	Art der Wartung:	Wartung durch Firma:
		Stempel
	
		Name / Unterschrift
		Wartung durch Firma:
		Stempel
	
		Name / Unterschrift

DE

**SM-600-GREENLINE / SM-600-GREENLINE-Power
SM-600-GREENLINE-POWER-FFS**



GB | Operating Instructions

1	Safety Instructions.....	4
1.1	Classification of safety instructions	4
1.2	Warnings	5
1.3	Mandatory symbols	5
1.4	Safety Marking.....	6
1.5	Regulations of these instructions	7
1.6	General safety instructions	7
1.7	Safety at work	9
1.7.1	General	9
1.8	Special Hazards	10
1.9	Intended use.....	10
1.10	Operator duties	12
1.11	Installation location/workplace requirements	13
1.11.1	Installation location requirements	13
1.11.2	Workplace requirements	14
1.12	Danger zone definition	14
1.13	Emissions.....	16
1.14	Personal protective equipment	16
1.14.1	Installation/decommissioning and disposal of the lifting device	16
1.14.2	Operating the lifting device	17
1.14.3	Troubleshooting/maintenance of the lifting device	17
2	Product Description	18
2.1	Components	18
2.2	Operating elements	20
2.3	Type plate.....	21
2.4	Vacuum generator	21
2.5	Suction plates	21
2.6	Safety features	21
3	Technical Data	22
3.1	Technical data of the remote control (only for SM-600-POWER-FFS)	22
4	Delivery, Packaging and Transport.....	23
4.1	Delivery	23
4.1.1	Items included in delivery	23
4.1.2	Check for completeness	23
4.1.3	Report damage	23
4.2	Packaging	23
4.3	Transport.....	23
4.4	Removing the lifting device from the pallet	24
5	Start of Operation.....	24
5.1	Tool list.....	24
5.2	Fastening lifting device	24
5.3	Mounting suction plate on the lifting device	25
5.4	Changing the suction plate	27

5.5	Power supply	27
6	Operation.....	28
6.1	General safety instructions regarding operation	28
6.2	Inspections before starting work.....	30
6.3	What to do in an emergency.....	30
6.4	Remote control option.....	31
6.5	Lifting the load – applying suction	31
6.6	Guiding the load.....	33
6.7	Putting the load down – releasing	34
6.8	Parking the lifting device	35
7	Storage	36
8	Troubleshooting.....	37
9	Maintenance	38
9.1	General notes	38
9.2	Replace battery.....	38
9.3	Vacuum generator	38
9.4	Suction plates/sealing lips.....	39
9.5	Inspecting safety features	39
9.5.1	Inspect flashing light	39
9.5.2	Inspecting suction hoses and clamps	39
9.5.3	Check airtightness.....	40
9.6	Filter.....	41
9.7	Drain condensation	41
9.8	Maintenance schedule	42
9.8.1	Mechanics	42
9.8.2	Remaining components	42
9.9	Annual inspection	43
9.10	Cleaning.....	44
9.11	Spare parts	44
10	Decommissioning and Disposal	44

EC-Declaration of Conformity / UKCA-Declaration of Conformity

Description: Stone magnet SM
Type: SM-600-GREENLINE / SM-600-GREENLINE-Power SM-600-GREENLINE-POWER-FFS
Order number: 52720006 / 52720007 / 52720008

Manufacturer: Probst GmbH
Gottlieb-Daimler-Straße 6
71729 Erdmannhausen, Germany
info@probst-handling.de
www.probst-handling.com



Importer: Probst Ltd
Unit 2 Fletcher House
Stafford Park 17
Telford Shropshire TF3 3DG, United Kingdom
www.probst-handling.co.uk
sales@probst-handling.co.uk



The machine described above complies with the relevant requirements of the following EU directives:
The object of the declaration described above is in conformity with the relevant UK-Regulations and UK-Guidelines:

EC-machinery directive 2006/42/EC (Reference: OJ L 157, 09.06.2006)

2014/30/EU (Electromagnetic compatibility)

UK-Regulation: Supply of Machinery (Safety) Regulations 2008 (SI 2008 No. 1597)

The following standards and technical specifications were used:

DIN EN ISO 12100

Safety of machinery - General principles for design - Risk assessment and risk reduction

UK-Regulation: BS EN ISO 12100-1:2003+A1:2009

2014/30/EU (Electromagnetic compatibility)

DIN EN ISO 13857

Safety of machinery - safety distances to prevent hazard zones being reached by upper and lower limbs.

UK-Regulation: BS EN ISO 13857:2019

DIN EN 1012-1 / DIN EN 1012-2

Compressors and vacuum pumps; safety requirements part 1 and 2.

DIN EN 60204-1 (IEC 60204-1)

Safety of machinery, Electrical equipment of industrial machines. Part 1: General requirements

Authorized person for EC-documentation:

Name: Jean Holderied

Address: Probst GmbH; Gottlieb-Daimler-Straße 6; 71729 Erdmannhausen, Germany

Authorized person for UK-documentation:

Name: Nigel Hughes

Address: Probst Ltd ; Unit 2 Fletcher House; Stafford Park 17; Telford Shropshire TF3 3DG, United Kingdom

Signature, information to the subscriber:

Erdmannhausen, 05.03.2024.....

(Eric Wilhelm, Managing Director)

1 Safety Instructions

1.1 Classification of safety instructions

Danger

This warning informs the user of a risk resulting in death or serious injury if it is not avoided.

 DANGER	
	<p>Type and source of danger</p> <p>Consequence</p> <p>▶ Remedial action</p>

Warning

This warning informs the user of a risk of death or serious injury if it is not avoided.

 WARNING	
	<p>Type and source of danger</p> <p>Consequence</p> <p>▶ Remedial action</p>

Caution

This warning informs the user of a risk of injury if it is not avoided.

 CAUTION	
	<p>Type and source of danger</p> <p>Consequence</p> <p>▶ Remedial action</p>











Caution

This warning informs the user of a risk of damage to property if it is not avoided.

CAUTION	
	<p>Type and source of danger</p> <p>Consequence</p> <p>▶ Remedial action</p>







1.2 Warnings

Explanation of the warning symbols used in the operating and maintenance instructions.

Warning symbol	Description	Warning symbol	Description
	General warning symbol		Explosive atmosphere
	Hand injury		Flying debris
	Suspended load		Crushing injury
	Vacuum		Fall hazard
	Falling parts		Hearing damage

1.3 Mandatory symbols

Explanation of the mandatory symbols used in the operating and maintenance instructions.

Mandatory symbols	Description	Mandatory symbols	Description
	Use ear protection		Wear protective footwear
	Wear protective gloves		Disconnect mains plug
	Adhere to the operating instructions		Wear protective eye wear

1.4 Safety Marking

PROHIBITION SIGN

Symbol	Meaning	Order-No.	Size
	It is not allowed to stand under hanging loads. Danger to life!	2904.0209	50 mm
	The sucked load must never be lifted and transported without additional securing by the load-securing-chain.	2904.0767	55 x 25 mm
	Do not lift any components off-centre.	2904.0383	

WARNING SIGN

Symbol	Meaning	Order-No.	Size
	Danger of squeezing the hands.	2904.0220	50 mm
	Reference to radio remote controlled device	2904.0647	130 x 50 mm

(optional)

REGULATORY SIGN

Symbol	Meaning	Order-No.	Size
	Each operator must have read and understood the operating instructions (and all safety instructions).	2904.0665 2904.0666	30 mm 50 mm
	Load-securing-chain must fit tightly to the load. Load-securing-chain should never hang loosely under the load!	2904.0690	25 x 55 mm
	Remove the suction hose before changing the suction plate.	2904.0322	65 x 88 mm

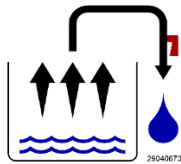

Drain condensation water from the unit every day.

2904.0673

40 x 40 mm

HINT SIGNS

Symbol	Meaning	Order-No.	Size
<p>(optional)</p>	Load suction and release	2904.0320	25 x 60 mm

1.5 Regulations of these instructions



WARNING	
	<p>Risk of injury from not observing this information</p> <ul style="list-style-type: none"> These operating and maintenance instructions are a fixed part of the “Standard” and “Power” stone magnet lifting device and contain important information on their use. These operating and maintenance instructions are specific to the items included in delivery from Probst GmbH. They do not take into account any modifications to the system made by the customer, which are strictly prohibited. The system may only be connected and started after reading and understanding the operating and maintenance instructions.



1.6 General safety instructions

	<p>This lifting device from the STONEMAGNET series, hereafter referred to as the lifting device, is state of the art and will operate reliably provided you comply with the requirements in these instructions. Incorrect use of the lifting device can result in serious risks.</p>
--	---------------------------------------------------------------------------------------------------------------------------------------------------------------------------------------------------------------------------------------------------------------------------------------------

WARNING	
	<p>Risk of injury from not observing the general safety instructions</p> <ul style="list-style-type: none"> Use only the connections, mounting holes and attachment materials that have been provided. Carry out assembly or disassembly work only when the device is depressurized. When work is performed on the lifting device, the operator must ensure that access to the transportation or lifting device (crane, chain hoist, construction vehicle, etc.) is restricted so no movement can occur.

	<ul style="list-style-type: none"> ▶ Only qualified specialist personnel and mechanics may perform the installation, maintenance and repair work. Qualified specialist personnel are persons who have received technical training and have the knowledge and experience – including knowledge of applicable regulations – necessary to enable them to recognize possible dangers and implement the appropriate safety measures while performing tasks. ▶ Observe and adhere to general safety regulations and European standards. ▶ Personnel and animals are not permitted to sit or stand in the danger zone area. ▶ The lifting device may only be used for its designated purpose (section 1.9). ▶ The lifting device may only be used to lift and transport suitable loads. ▶ You are responsible for third parties in the lifting device’s working area. In view of this, responsibilities must be clearly specified and observed when carrying out various tasks on the system. Those responsible must be aware of their competency. ▶ Never use the lifting device to apply suction to fluids or bulk materials. ▶ Protect the components from damage of any kind.
--	----------------------------------------------------------------------------------------------------------------------------------------------------------------------------------------------------------------------------------------------------------------------------------------------------------------------------------------------------------------------------------------------------------------------------------------------------------------------------------------------------------------------------------------------------------------------------------------------------------------------------------------------------------------------------------------------------------------------------------------------------------------------------------------------------------------------------------------------------------------------------------------------------------------------------------------------------------------------------------------------------------------------------------------------------------------------------------------------------------------------------------------------------------------------------------------------------------------------------------------------------------

 WARNING	
 	<p>Risk of injury from not observing the general safety instructions</p> <p>Personal injury / damage to plants / systems</p> <ul style="list-style-type: none"> ▶ The permissible upper and lower load limits are defined in the “Technical Data” section and must be observed. ▶ The safety features must be in perfect working order and must be switched on/set up for the process.

 WARNING	
	<p>Risk of injury from exposed vacuum suction points</p> <ul style="list-style-type: none"> ▶ Never look or reach into the openings of suction points or place your ear or other body orifices in the vicinity of these openings. ▶ The device generates very high suction that can suck in hair and items of clothing.

	<p>All applicable laws and regulations must be adhered to at all times.</p> <p>When using the lifting device, the statutory regulations, safety regulations, standards and guidelines applicable at the location of use must be observed. Check with the competent authorities for more information. The safety instructions in these operating and maintenance instructions do not replace these laws and regulations, but are to be regarded as a supplement to them.</p>
-------------------------------------------------------------------------------------	------------------------------------------------------------------------------------------------------------------------------------------------------------------------------------------------------------------------------------------------------------------------------------------------------------------------------------------------------------------------------------------------------------------------------------------------------------------------------------

1.7 Safety at work

1.7.1 General



Prohibition

- ▶ **The use of the vacuum lifting device is only permitted in proximity to the ground. In hoist operation:** The suctioned load must be lowered immediately after picking up (e.g. from a pallet or a truck) to just **above the ground** (approx. 20 - 30 cm). The load must then be secured by the **load securing chain** and may only then be transported to the installation site. To transport the load, lift it only as high as necessary (recommended approx. 0.5 m above the ground).

It is forbidden to swivel the device over persons. Danger to life!



- ▶ The manual guiding of is only allowed for devices with handles.
- ▶ The operator is not allowed to leave the control unit as long as the vacuum lifting device loaded with load (stone slab).
- ▶ The operator must always keep an eye on the manometer. Only lift the load (e.g. stone slab) when the required vacuum vacuum has been reached. If the pointer of the manometer moves into the red area under the required vacuum vacuum, **immediately lower the load. Danger to life - load will fall!**



Prohibition

- While using the vacuum lifting device is the stay of persons in the working area **forbidden**. Except it is indispensable. Caused of the way of using the vacuum lifting device , e.g. if the device must be leaded by hand (at the handles).
- It is forbidden to stay under a lifted load. Danger to life!
- The device must never be subjected to a force acting in a lateral direction due to diagonal pulling.



- Do not lift load off-centre, because that could fall down. **Danger of tilting!**
- Release the load only when it is completely safely resting on the surface. Keep fingers away from the load when you release it. **Danger of squeezing the hands!**
- The load capacity and nominal widths/nominal sizes of the device must not be exceeded.
- Do not tear off any stuck loads with the device.



Prohibition

- **Jerking up or down** of the unit with or without load is **prohibited!** Unnecessary vibrations must be avoided. As well as **fast driving** with the carrier/ hoist over uneven terrain! Danger to life/accident: The load could fall or the load handling attachment could be damaged! As a general rule, **only** drive at **walking speed** with the lifted load!

1.8 Special Hazards





Prohibition



- ▶ The operating range has to be covered for unauthorized persons, especially children.
- ▶ The workplace has to be sufficiently illuminated.
- ▶ Take care when handling wet, dirty and not solidified components.
- ▶ **The working with the vacuum lifting device in case of atmospheric editions under 37,5° F (3° C) is forbidden! Because the goods could be fall down caused by dampness or freezing.**
- ▶ Take care in case of thunderstorm!
- ▶ Since the load is held on the suction plates of the unit by a vacuum, it will fall off as soon as this vacuum is lost (e.g. energy failure).
- ▶ This can happen if the vacuum generator fails. An integrated vacuum reservoir maintains the vacuum for a short safety period whose duration depends on the porosity of the work piece surface.
- ▶ If the vacuum generator fails, lower the load immediately if this is possible. Otherwise, leave the danger area below the load immediately.

1.9 Intended use

The lifting device is used for the lifting and transporting at low altitudes (see chapter “Safety at work”) of flat, thick and non-porous granite, marble, WET CAST and other stone slabs, as well as concrete elements, natural stones, sandstone steps, clay pipes, etc., provided a vacuum of -0.6 bar is available, using appropriate transportation or lifting devices (crane, chain hoist, construction vehicle, etc.).

 WARNING	
	<p>Danger due to falling objects from using improper suction plates.</p> <ul style="list-style-type: none"> ▶ The suction plate is not included in delivery. The user must ensure that only suction plates suitable for the load to be lifted are used. Maximum load capacity: 600 kg ▶ The suction plate holder must comply with the requirements outlined in chapter 5.3. Other suction plate holders are not permitted. ▶ The suction surface of the load to be lifted must be airtight – i.e., when the vacuum generator is switched off, the load being gripped must be held for another five minutes. You may need to verify this by performing tests.

The load (stone slab) to be picked up and transported must be sufficiently rigid. Otherwise, **risk of breakage** can result during lifting.

Stone slabs may not sag **under any circumstance**. Particular attention must be made for thin and large-format stone slabs.

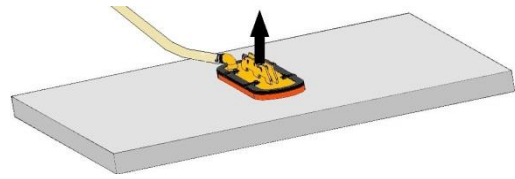

Generally, the load (stones slab) is only to be sucked in the **middle**, otherwise the load hangs diagonally under the device which may cause a breaking of the load - especially when lifting large stone slabs with a small suction plate.

Standard suction plates are not suitable for transporting glass sheets.

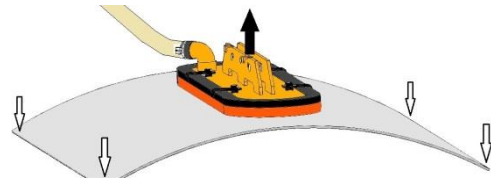

DANGER	
	<p>Suction plates have different loads</p> <p>Danger from falling loads (stone slabs)</p> <ul style="list-style-type: none"> ▶ Some suction plates installed on the device reduce its load capacity. The permissible load capacity is specified on each suction plate. Only suction plates manufactured by PROBST may be used. ▶ Exceeding the permissible and specified suction plate load capacity is not allowed under any circumstance.







The lifting device is not delivered with suction plates.

The customer is required to carry out a conformity assessment according to Article 12 of the Machinery Directive 2006/42 (see section 5.3).

The permissible upper and lower load limits are defined in Section 3 (Technical Data) and must be observed. Also refer to the type plate or sticker for details of the maximum permissible load capacity.

You may not make any independent modifications or changes to the lifting device. It may only be operated in the original condition as delivered.

 WARNING	
	<p>There is a risk that the load may fall, crushing body parts or fatally injuring people in the vicinity.</p> <p>Independent modifications and changes compromise the lifting device's required integrity. Its function may also be compromised.</p> <p>▶ Do not make any on-site modifications to the system.</p>

 WARNING	
	<p>Danger of death from falling if used as a means of transport for humans or animals, or as a climbing aid.</p> <p>This can result in broken bones, serious injury or even death.</p> <p>▶ Use of the lifting device as a climbing aid or to transport humans or animals is prohibited.</p>

1.10 Operator duties

The lifting device may only be installed and maintained by qualified specialist personnel and mechanics.



Qualified personnel is defined as: an employee who has received technical training and has the knowledge and experience – including knowledge of corresponding regulations – necessary to enable him or her to recognize possible dangers and implement the appropriate safety measures while performing tasks. Qualified personnel must observe the relevant industry-specific rules and regulations.



The user's company must ensure by means of internal measures that all persons at the company commissioned with the task of setting up, starting, operating, maintaining and repairing the lifting device employ only insured persons who:

- Are at least 18 years of age and are mentally and physically fit for the task
- Have been trained in operating and maintaining the lifting device
- Have read and understood the operating and maintenance instructions
- Can be expected to reliably perform the tasks assigned to them



The operating and maintenance instructions must be accessible at all times and retained for use at a later date.

 WARNING	
	<p>Risk of injury from misuse or non-observance of warning and safety notices</p> <p>▶ The equipment must be used by trained personnel only. ▶ Follow local regulations on work breaks to prevent accidents due to negligence.</p>

- The lifting device's function and condition must be inspected before use every time (see section o).
- Lifting device may only be maintained, lubricated and corrected of faults when not in use.
- When defects compromising safety are found, the lifting device must be completely corrected of faults before being used again.
- When cracks are found on load-bearing parts, the lifting device must be prevented from any further use.
- The lifting device operating instructions must be visible on site at all times.
- The type plate on the lifting device may not be removed.
- Illegible indicating signs must be replaced.

1.11 Installation location/workplace requirements

1.11.1 Installation location requirements

 DANGER	
	<p>Switching components that are not explosion-proof</p> <p>Risk of fire and explosion</p> <p>▶ The lifting device may not be used in areas subject to explosions.</p>

 WARNING	
	<p>Risk of explosion from flammable material being sucked in</p> <ul style="list-style-type: none"> ▶ Ensure that no flammable material (fuel, solvents, etc.) can be taken in before coming in contact with the lifting device.

CAUTION	
	<p>Damage to the lifting device from operation in areas with acidic or alkaline materials or in contaminated atmospheres.</p> <ul style="list-style-type: none"> ▶ Consult with the manufacturer before operating in an area with aggressive atmospheric conditions.

The lifting device can be operated at temperatures between 3° C and 40° C.

CAUTION	
	<p>Damage to the lifting device due to use outside of the permitted temperature range</p> <ul style="list-style-type: none"> ▶ Only use the lifting device at the permitted ambient temperature. ▶ Consult with the manufacturer before operating outside of the permissible temperature range.

1.11.2 Workplace requirements

The operator's workplace is in front of the handle. Ensure that the operator can constantly monitor the entire workspace. The workplace must be lit sufficiently and glare-free.



Ensure the area around the workplace is always clean and tidy by providing appropriate internal instructions and conducting checks.

CAUTION	
	<p>Damage to the lifting device from small parts being sucked in</p> <ul style="list-style-type: none"> ▶ Keep the site and vicinity of the lifting device free of small parts.

1.12 Danger zone definition

- The danger zone is the area inside, or in the vicinity of working equipment that poses a hazard or potential hazard to the health of persons located within this area.
- Lifting the load or transporting may result in the load and the lifting device falling or being lowered. Therefore, the area directly below the lifting device is essentially a danger zone.
- During horizontal transport, note that lifting, horizontal acceleration and braking of the load may cause it to rotate, tilt or swing. The vicinity of the load is therefore a danger zone.
- It is also necessary for the rigger to maintain a sufficiently safe distance when guiding the load (always use the handle to guide the load).



- Never walk in front of the load – unexpected obstacles could cause you to trip while the load is approaching you. The load also swings in your direction when horizontal travel is stopped. It is not possible to watch/monitor both the transport path and the load at the same time.
- In the event that the load falls, the danger zone depends greatly on the transport height and is therefore difficult to assess. Loads should always be suspended as close to the floor as possible.

 WARNING	
	<p>Risk of injury from falling objects in case of:</p> <ul style="list-style-type: none"> - Vacuum failure - The load breaking off due to a collision - Components failing due to incorrect loads and overloads or unauthorized modifications <p>There is a risk of death or seriously injury from hitting people in the</p> <ul style="list-style-type: none"> ▶ Secure the working area from unauthorized persons, particularly children. ▶ The load must be secured every time with the load safeguard chain before transporting. ▶ Loitering below overhead loads is not allowed. ▶ Only work when you have a good view of the entire working area. ▶ Pay attention to other people in the working area. ▶ Never transport the load above people. ▶ Always keep the load's center of gravity in the working area of transportation or lifting devices (cranes, chain hoists, construction vehicles, etc.). ▶ Never release the handle of the lifting device while lifting a load. ▶ The working area must be secured by the operator. The persons/equipment necessary to secure this area must be present during the lifting/transportation process.

1.13 Emissions



The lifting device emits noise and exhaust air.

The continuous sound pressure output by the device is less than 70 db(A).

 CAUTION	
 	<p>Noise pollution from vacuum generator</p> <p>Noise pollution can cause hearing damage.</p> <p>▶ Wear ear protection</p>

The vacuum generator will atomize and disperse any media that is sucked in. It is therefore important that no polluted or contaminated ambient air (particle size max. 5 µm) is sucked in.

 CAUTION	
	<p>Danger of poisoning from emission of exhaust gases</p> <p>▶ Ensure that no exhaust gases can be sucked in before turning on the lifting device.</p>

 CAUTION	
	<p>Risk of eye injury</p> <p>All vacuum generators generate an exhaust air flow. Depending on the purity of the ambient air, this exhaust air can contain particles, which escape from the exhaust air outlet at high speed, potentially injuring people in the face and eye area.</p> <p>▶ Do not look into the exhaust air flow.</p> <p>▶ Wear protective eye wear.</p>

1.14 Personal protective equipment

Always wear suitable protective equipment.

1.14.1 Installation/decommissioning and disposal of the lifting device

- Protective footwear (in accordance with EN 20345 safety class S1 or better)
- Sturdy work gloves (in accordance with EN 388 safety category 2133 or better)
- Industrial helmet (in accordance with EN 397)
- Ear protection (in accordance with EN 352 class L or higher)
- Other protective equipment as required by the situation or prescribed by national regulations.

1.14.2 Operating the lifting device

- Protective footwear (in accordance with EN 20345 safety class S1 or better)
- Sturdy work gloves (in accordance with EN 388 safety category 2133 or better)
- Industrial helmet (in accordance with EN 397)
- Other protective equipment as required by the situation or prescribed by national regulations.

1.14.3 Troubleshooting/maintenance of the lifting device

- Protective footwear (in accordance with EN 20345 safety class S1 or better)
- Sturdy work gloves (in accordance with EN 388 safety category 2133 or better)
- Protective eye wear (class F)
- Ear protection (in accordance with EN 352 class L or higher)
- Other protective equipment as required by the situation or prescribed by national regulations.

2 Product Description

2.1 Components

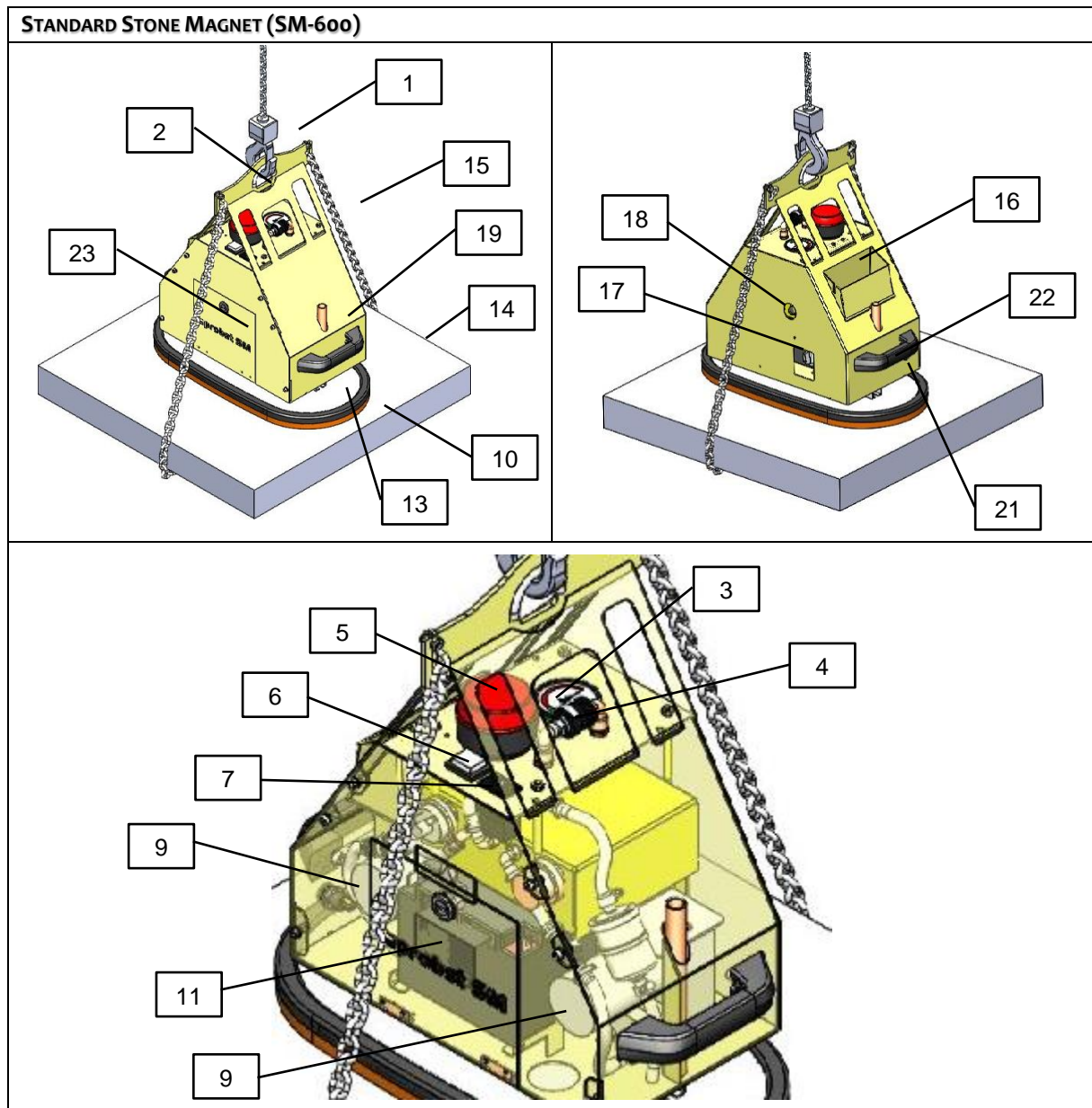

Item	Description	Item	Description
1	Crane hook (not included in delivery)	12	Dirt filter
2	Hanger	13	Suction plate C rail (not included in delivery)
3	Vacuum gauge (manometer)	14	Load (stone slab)
4	Manual slide valve	15	Load safeguard chain
5	Red flashing light	16	Chain box
6	On/off switch (with three settings)	17	Blow off valve
7	Battery charge level indicator	18	Sight glass
8	Housing with vacuum reservoir	19	Suction plate mounting hole
9	Vacuum pumps	21	Charging socket
10	Suction plate (not included in delivery)	22	Handle
11	Rechargeable battery	23	Device cover

POWER STONE MAGNET (SM-600-POWER / SM-600-POWER-FFS)

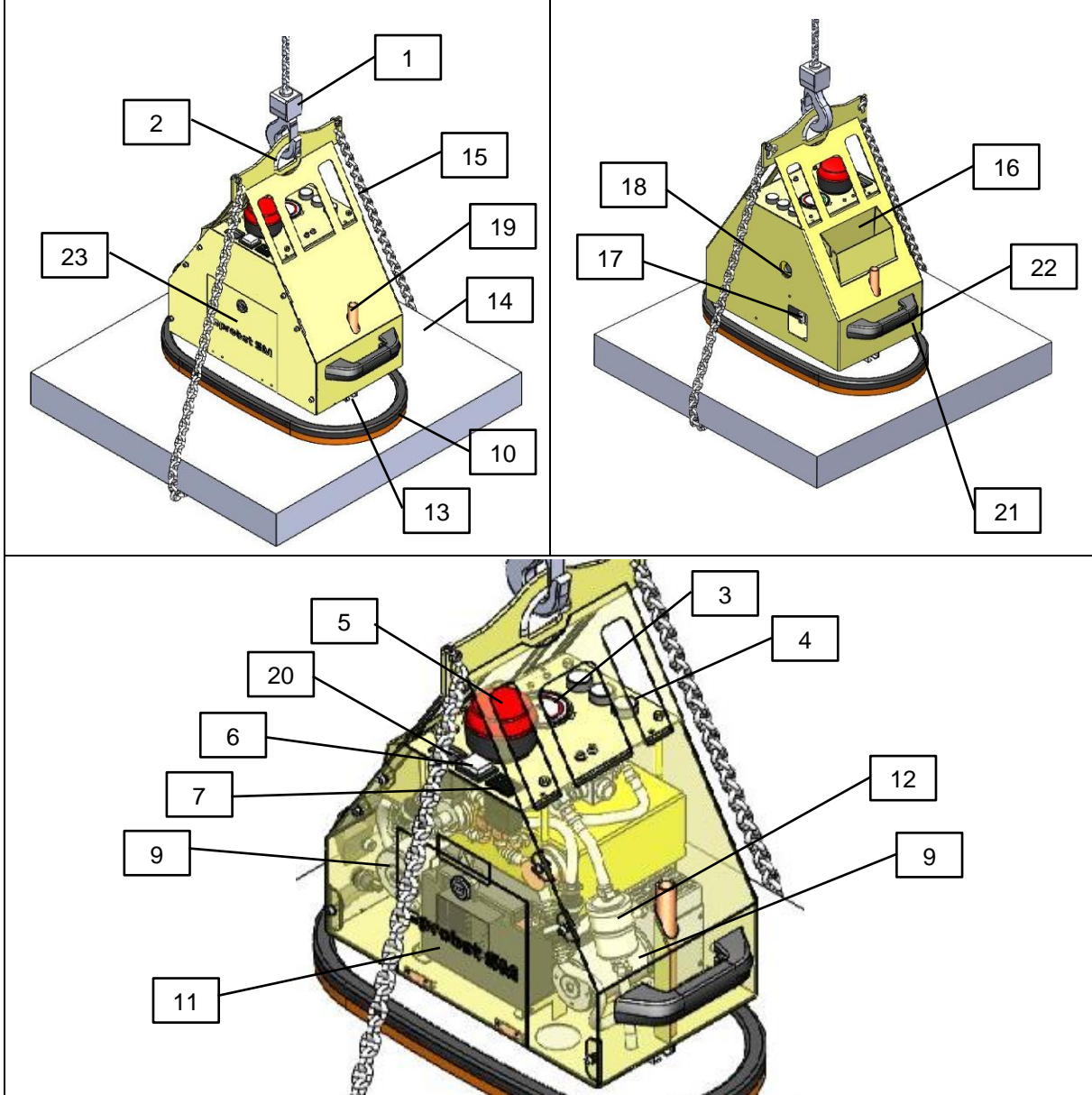

Item	Description	Item	Description
1	Crane hook (not included in delivery)	13	Suction plate C rail (not included in delivery)
2	Hanger	14	Load (stone slab)
3	Vacuum gauge (manometer)	15	Load safeguard chain
4	Operating buttons	16	Chain box
5	Red flashing light	17	Blow off valve
6	On/off switch (with three settings)	18	Sight glass
7	Battery charge level indicator	19	Suction plate mounting hole
8	Housing with vacuum reservoir	20	Counter of hours of operation
9	Vacuum pumps	21	Charging socket
10	Suction plate (not included in delivery)	22	Handle
11	Rechargeable battery	23	Device cover
12	Dirt filter		

2.2 Operating elements

Standard Stone Magnet SM-600-POWER	Power Stone Magnet SM-600-POWER SM-600-POWER-FFS
----------------------------------------------	--------------------------------------------------------------

Applying suction to the load

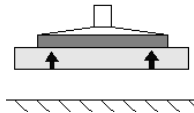

<p>Locking button</p>		<p>Remote control option</p>
<p>Press the locking button at the same time to slide the manual slide valve.</p>		

Releasing the load

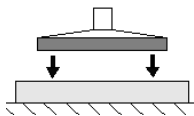

<p>Locking button</p>		<p>Remote control option</p>
<p>Press the locking button at the same time to slide the manual slide valve.</p>	<p>Press both buttons at the same time to release.</p>	

2.3 Type plate



The type plate is used to identify the device. Always provide the specifications on the type plate when ordering spare parts, making warranty claims or for other inquiries about the device.

The type plate is attached firmly to the exterior of the lifting device.

The type plate contains the following information:

- Device type
- Part number
- Order number
- Serial number
- Year of manufacture
- Device weight
- Load-bearing capacity
- Voltage

2.4 Vacuum generator

Turn on the vacuum generator using the on/off switch or one or two vacuum pumps.

1 vacuum pump Longer battery life

2 vacuum pumps Shorter evacuation time and higher airflow

If the vacuum falls below -0.53 bar, the vacuum pumps automatically turn on and raise the vacuum pressure back to -0.66 bar.

2.5 Suction plates

Suction plates (not included in delivery) are for applying suction to the load (see section 5.3). Only objects with flat, dense surfaces are suitable to be lifted with this device.

2.6 Safety features

The lifting device has the following safety features:

- ⇒ Red flashing light (monitors the operating vacuum and power failures)
- ⇒ Vacuum switches
- ⇒ Gauge with red danger range indicator
- ⇒ 1 vacuum reservoir
- ⇒ Load safeguard chain

Inspect safety features (see section 9.2 for maintenance interval)

3 Technical Data

	Standard SM-600	Power SM-600-POWER /-POWER-FFS
Max. lift capacity*	600 kg	
Weight (without suction plate)	Approx. 34 kg	Approx. 35 kg
Vacuum reservoir volume	approx. 2.5 l	
Vacuum pump suction capacity		
Switch setting 1 (1 pump running)	29 l/min	52 l/min
Switch setting 2 (2 pumps running)	58 l/min	104 l/min
Max. final pressure	500 mbar vacuum	
Operating temperature range	+3 °C to 40 °C	
Voltage	DC 12 V	
Current consumption		
Switch setting 1 (1 pump running)	3.8 A	4.5 A
Switch setting 2 (2 pumps running)	7.6 A	9.0 A
Medium to be pumped	Ambient air	



* The maximal load capacity of the lifting device depends on the suction plate (not included in delivery, see section 5.3)

 DANGER	
	<p>Risk of injury from exceeding capacity load</p> <p>▶ The permissible load capacity of the transportation or lifting device (e.g. crane, chain hoist, construction vehicle, etc.) and the hoist must be high enough at least to be equal to the combined weight and load capacity of the lifting device.</p>

3.1 Technical data of the remote control (only for SM-600-POWER-FFS)

	Power SM-600-POWER-FFS
Frequency band	2405-2480 MHz
Amount of Channels	16 (channel 11-26)
IP code	67
Operating temperature	-20 – +55 °C / -4 – +130 °F

4 Delivery, Packaging and Transport

4.1 Delivery

4.1.1 Items included in delivery

Refer to the order confirmation for specific details about what is included in delivery. The weights and dimensions are listed in the delivery notes.



The operating and maintenance instructions are an integral part of the lifting device and must accompany the device whenever it moves to a new location.

4.1.2 Check for completeness

Compare the entire delivery with the supplied delivery notes to make sure nothing is missing.

4.1.3 Report damage

Following delivery of the shipment, damage caused by defective packaging or in transit must be reported immediately to the carrier and Probst GmbH.





4.2 Packaging

The lifting device is delivered packaged on pallet.



The packaging material must be disposed of in accordance with country-specific laws and guidelines. Labeled transport aids and safety mechanisms must be removed.

4.3 Transport



 WARNING	
  	<p>Risk of injury due to improper transportation and unloading This can result in personal injury or material damage.</p> <ul style="list-style-type: none"> ▶ Unloading and transport may only be carried out by trained forklift truck drivers who have also completed all necessary safety training ▶ Hoists and slings must have the necessary specifications for the particular load. ▶ Transport materials must be secured in accordance with country-specific regulations (BAG guidelines in Germany). ▶ Personal protective equipment

4.4 Removing the lifting device from the pallet

The packaging must be opened carefully.

Take care not to damage any of the components when opening the packaging with knives or blades.

Now carefully remove the lifting device.

 CAUTION	
	<p>Heavy components on the pallet</p> <p>Take care when opening the packaging as parts may have slipped and could fall. This can cause crushing wounds and lacerations.</p> <p>▶ Wear protective footwear (S1) and work gloves (safety category 2133).</p>

CAUTION	
	<p>Improper removal of system from the transportation box</p> <p>System damage</p> <p>▶ Do not apply force</p> <p>▶ Observe the instructions for removing the system from the transportation</p>

5 Start of Operation





The following operating steps must be checked by a qualified employee before the starting for the first time and section 1.10 (Requirements and instructions for installation, maintenance and operating staff) must be read.

5.1 Tool list

No tools are required for installation.

5.2 Fastening lifting device

 WARNING	
	<p>Risk of load breaking off due to incorrect mounting</p> <p>Falling parts could hit people in the vicinity, causing death or serious injury!</p> <p>▶ The lifting device may only be lifted on the suspension eye.</p> <p>▶ The permissible load capacity of the transportation or lifting device (e.g. crane, chain hoist, construction vehicle, etc.) and the hoist must be high enough at least to be equal to the combined weight and load capacity of the lifting device.</p> <p>▶ The transportation or lifting device used and the hoist must be in perfect working condition.</p>

5.3 Mounting suction plate on the lifting device

The suction plate and mounting material are not included in delivery.

 DANGER	
	<p>Risk of injury from turning on by accident.</p> <ul style="list-style-type: none"> ▶ Turn off the lifting device before mounting the suction plate.

 DANGER	
	<p>Risk of injury from improper mounting material.</p> <ul style="list-style-type: none"> ▶ The suction plate must be chosen by the customer depending on the load (surface, thickness, weight). The customer is required to document the static strength and holding force depending on the potential vacuum and to adhere to safety factors. The Standard DIN EN 13155 in its current valid version should be used as a template for mounting. ▶ The suction plate must be mounted with the appropriate mounting material. <ul style="list-style-type: none"> • 2 M12 – 4.6 threaded spindles, length: 247 mm • 2 DIN 582 E – M12 – C15 zinc-coated ring nuts

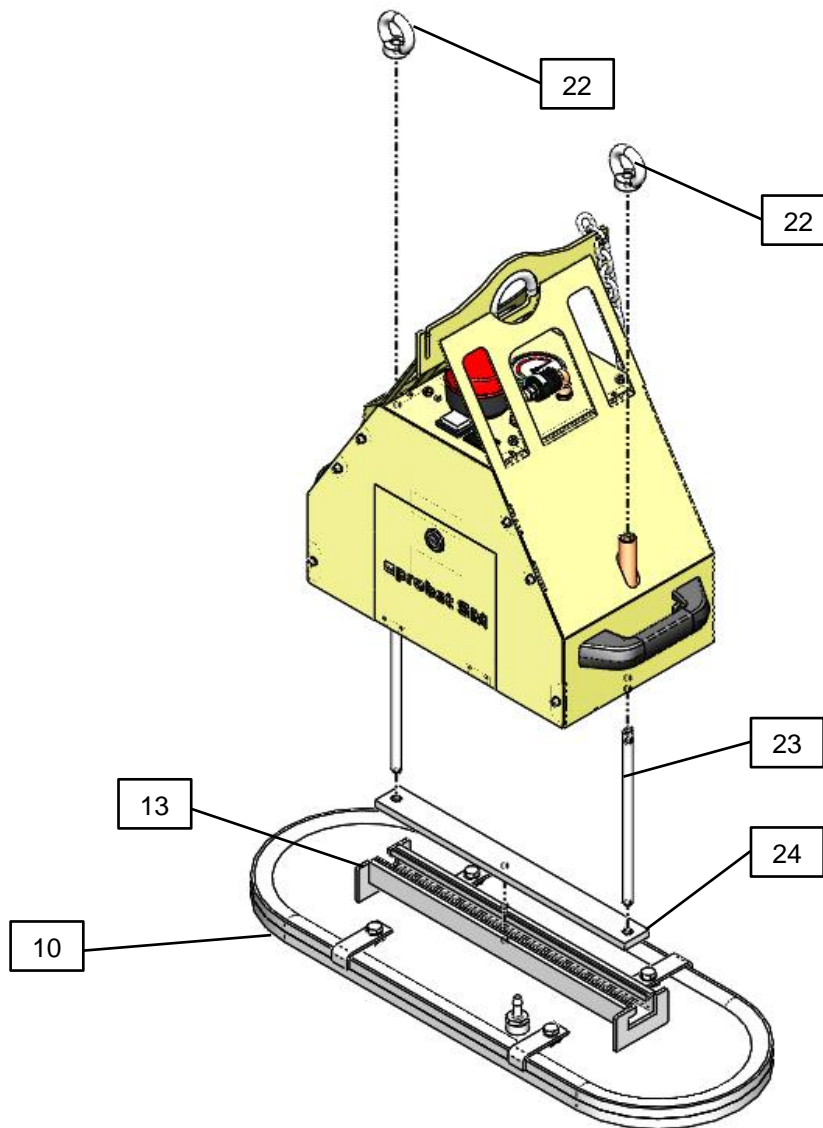

Suction plate mounting material is not included in delivery

Item	Description	Item	Description
10	Suction plate	23	Threaded rod
13	C rail	24	Sliding block
22	Ring nut		

1. Both threaded spindles must be screwed into the sliding block so the thread is completely screwed in.
2. Insert both threaded spindles into the two mounting holes from below until the threaded spindles protrude out of the housing on top.
3. Screw the ring nut/2-3 threads loosely onto the threaded spindles.
4. Slide the suction plate C rail over the sliding block from the side.
5. Position the suction plate in the center.
6. Screw the ring nuts tightly and check to see if the suction plate is secure.
7. Attach the vacuum hose to the suction plate.
8. Check airtightness (see section o).
9. Inspect safety features before working with loads.



Installation of the lifting device is complete after 3-4 successful test runs with a load. A type test covers the inspections required in Europe before initial use in accordance with DIN EN 13155.

5.4 Changing the suction plate

1. Place the lifting device on a clean, even area.
2. Turn the lifting device off.
3. Remove the vacuum hose.
4. Loosen the ring nuts.
5. Lift the lifting device while keeping the suction plate steady.
6. Attach the new suction plate onto the lifting device (see section 5.3).
7. Store unused suction plate in a suitable location (see section 7).

5.5 Power supply

The lifting device is powered by an integrated battery. An external power supply during operation is not required.



Charging the battery takes around one work day.

The battery must be charged after each use so that the lifting device remains ready for use at all times.

The battery can be charged constantly.

A replacement battery can be stored, as well (see section 9.2 for information on changing the battery).





6 Operation



Note on renting:

The original operating instructions must be delivered with the lifting device upon rental under all circumstances (if the country using the device speaks another language, the respective translation of the original operating instructions must be delivered, as well).

6.1 General safety instructions regarding operation

 WARNING	
	<p>Non-observance of the general safety instructions for normal operation</p> <p>This can result in personal injury or damage to the system.</p> <p>▶ The system may only be operated by trained personnel who have read and understood the operating and maintenance instructions.</p>
 WARNING	
	<p>Risk of injury due to high vacuum and flow rate</p> <p>Hair, skin, body parts and items of clothing can be sucked in.</p> <ul style="list-style-type: none"> ▶ Closely fitting clothing and a hairnet must be worn. ▶ Do not look into the opening of the suction connection. ▶ Do not reach into the opening of the suction connection. ▶ Do not position in the vicinity of body orifices.



WARNING



Prohibition

Danger due to falling objects in the event of:

- Vacuum failure
- Collision, causing the load to break off
- Component failure resulting from overload or unauthorized modifications

There is a risk of death or seriously injury from hitting people in the vicinity.

- ▶ No person may sit or stand in the danger zone of the load.
- ▶ Never transport the load above people.
- ▶ Suitable protective equipment must be worn prior to transport.
- ▶ Do not operate unless you have a clear view of the entire working area.
- ▶ Pay attention to other people in the working area.
- ▶ Never release the lifting device handle while lifting a load.
- ▶ Never lift loads at an angle and never drag or pull them.
- ▶ Do not use the lifting device to free stuck loads.
- ▶ Only apply suction to and lift suitable loads (test their intrinsic stability and porosity).
- ▶ The working area must be secured by the user/operator. The persons/equipment necessary to secure this area must be present during the lifting/transportation process.
- ▶ The permissible load per suction plate must not be exceeded.
- ▶ Do not place parts on the lifting device.
- ▶ The vacuum may not be turned off at any time during handling.
- ▶ Lift and transport **the load only with fastened load-securing chain!**

- ▶ **The use of the vacuum lifting device is only permitted in proximity to the ground.**

In hoist operation: The suctioned load must be lowered immediately after picking up (e.g. from a pallet or a truck) to just above the ground (approx. 20 - 30 cm).

The load must then be secured by the load securing chain and may only then be transported to the installation site. To transport the load, lift it only as high as necessary (recommended approx. 0.5 m above the ground).

It is forbidden to swivel the device over persons. Danger to life!



6.2 Inspections before starting work

 WARNING	
	<p>Danger from falling objects.</p> <ul style="list-style-type: none"> ▶ 1. Check the charging status of the battery (display item 7, see section 9.2 on changing the battery). <ul style="list-style-type: none"> • The battery is full if the GREEN light of the battery charge level indicator is on in the first 10 seconds after switching on. • After 10 seconds the battery charge level indicator may switch to YELLOW. • The lifting device can be used. • Charge the battery before use if the YELLOW or the RED light of the battery charge level indicator is on, just when switching on. • A fully charged battery lasts around one work day. • The battery must be charged after each use so that the lifting device remains ready for use at all times. • The battery can be charged constantly. 2. Check the condition of the suction plate. 3. Ensure that the suction plate is securely attached. 4. Inspect safety features (see section 2.6). 5. Inspect seals and replace if necessary. 6. Check condensation and drain if necessary (see section 9.7). 7. Ensure that the transportation or lifting device used (e.g. crane, chain hoist, construction vehicle, etc.) and the hoist are suitable (see section 3 for max. load capacity).

6.3 What to do in an emergency

The following cases constitute an emergency:

- Vacuum supply failure (e.g. vacuum generation turns off → during power failure). In such cases, a built-in reservoir maintains the vacuum for a short safety period (depending on the density of the load surface).
- Leakage (e.g. detached hose)
- Force resulting from a collision
- The vacuum level falls into the red zone on the gauge (less than -0.6 bar) while handling the load.

 WARNING	
	<p>Risk of injury due to reduction in the vacuum level in the event of a power failure or vacuum generator failure</p> <p>Persons will be crushed and injured.</p> <ul style="list-style-type: none"> ▶ The operator must sound the alarm immediately in the event of danger. ▶ Stay clear of the danger zone at all times. ▶ If possible, set down the load safely.

6.4 Remote control option

The radio remote control has been tested and complies with the statutory limits for a Class B digital device according to Part 15 of the FCC Regulations. These statutory limits should properly protect against harmful interference in residential areas.

The radio remote control produces, uses and emits high frequencies that could disrupt radio traffic if not used in accordance with these instruction.



However, there is no guarantee that interference will not occur in a particular installation. In case the radio remote control causes radio or TV reception interference that can be determined by turning the device off and on, it is recommended to resolve the interference using one or more of the following measures:

- Realign reception antennae or change their positioning.
- Increase the distance between radio remote control and receiver.
- Consult a dealer or experienced radio/TV specialist.

 CAUTION	
	<p>Risk of injury from uncontrolled movement of the lifting device</p> <ul style="list-style-type: none"> ▶ Always keep the path and load in eyesight. Only work when you have a good view of the entire working area. ▶ Ensure that no one is within the danger zone before releasing the load.



6.5 Lifting the load – applying suction

 WARNING	
	<p>Risk of injury from falling objects</p> <ul style="list-style-type: none"> ▶ Secure load using load safeguard chain before transporting. ▶ Only lift a load with a minimum vacuum value of -0.6 bar (manometer in green zone). Otherwise, the holding force is not sufficient. ▶ Do not suddenly lift or lower the load. ▶ Loads with moist, wet, oily, icy, dirty, dusty surfaces or surfaces with decreased friction must be cleaned before applying suction. ▶ The maximum lift capacity of the individual suction plates must not be

 WARNING	
	<p>Risk of injury from uncontrolled movement of the lifting device</p> <ul style="list-style-type: none"> ▶ Always grip the load in its center of gravity. ▶ The load must be loose. ▶ The load must not adhere to anything. ▶ The load must not be tilted.

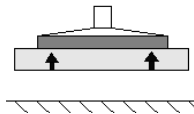
Applying suction to the load

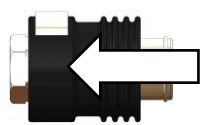
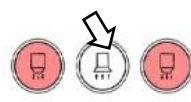

Standard Stone Magnet	Power Stone Magnet	
	SM-600-POWER	SM-600-POWER-FFS
<p>Press the locking button at the same time to slide the manual slide valve.</p>		<p>Remote control option</p> 

1. Position the lifting device over the load's center of gravity.
2. Ensure that the entire suction plate area is mounted on the load.
3. Secure load using load safety chain.
 - Lift the device with the sucked load just a little (approx.. 20-30 cm)
 - Throw the safety chain underneath the load (concrete slab) .
Never grip with the hands under load. - Caution: Danger of squeezing hands!!!
 - Suspend and tighten both safety chains. Place the end of the chains into the chain cases.
 - The safety chain must fit tightly to the load (see following figure), in that way that the load is held in case of a vacuum failure
 - **The safety chain must never hang loose under the load, otherwise the load may fall down, in case of a vacuum failure . Danger of accident!**
4. Do not lift the load at an angle.
5. Switch on the energy supply.
→ Light flashes until the vacuum reaches -0.6 bar.
6. Actuate operating element (see figure above according to model).
7. Watch the gauge. Lift the load as soon as the vacuum reaches -0.6 bar (manometer pointer is in the green zone).

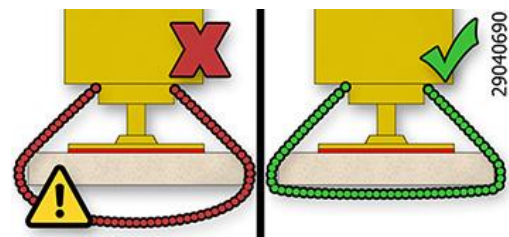

6.6 Guiding the load

 WARNING	
	<p>Risk of injury from uncontrolled movement of the lifting device</p> <ul style="list-style-type: none"> ▶ Use the handle to guide the load. Maintain a safe distance. ▶ Always keep the path and load in eyesight. Do not walk in front of the load. Tripping hazard The load swings in the direction of movement when horizontal travel stops. ▶ Always transport loads as close to the ground as possible and adjust transport speed to the working conditions. ▶ Do not jerk the lifting device as this could cause the device to rotate or swing.

WARNING	
	<p>Risk of injury from falling objects</p> <ul style="list-style-type: none"> ▶ Never quickly move the lifting device with lifted load over uneven surfaces.

6.7 Putting the load down – releasing

WARNING	
 	<p>Danger due to tilting parts</p> <ul style="list-style-type: none"> ▶ Lower the load carefully (distance to the ground approx. 20-30 cm), then remove Load-securing chains and throw it under the load. ▶ Never grip with the hands under load (stone slab)! Danger of squeezing!!! Safety chain should be returned to chain case. ▶ The load must be securely on the floor or in a suitable storage device before releasing the load from the lifting device. ▶ Before releasing the load from the lifting device, it must be secured from sliding or tilting as necessary. ▶ Once the load has been held by the load securing chain, the load securing chain must be properly tested and replaced if necessary. <p>Damaged load-securing chains must not be used any further!!</p>

Releasing the Load

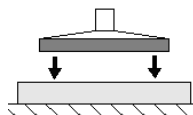

Standard Stone Magnet SM-600	Power Stone Magnet SM-600-POWER SM-600-POWER-FFS	
		<p>Remote control option</p>
<p>Press the locking button at the same time to slide the manual slide valve.</p>	<p>Press both buttons at the same time to release.</p>	

1. Lower the load and put it down safely on an open, even area.
 2. Ensure that the load can not slide or tilt.
 3. Actuate operating element to lower (see figure above according to model).
- The load is released. The lifting device can be lifted again.

6.8 Parking the lifting device

Setting down the lifting device briefly in the off state is referred to as 'parking'.

Procedure:

1. Switch off the energy supply.
2. Drain condensation if necessary (see section 9.7).
3. Hang the lifting device in a safe position on the transportation or lifting device. Do not set it down on the load.

7 Storage

Possible correct storage when not in use:

- Hang the lifting device hanging or
- Store the lifting device vertically.
IMPORTANT Remove the suction plate and store it separately before disconnecting.

CAUTION	
	<p>Suction cup damage suction cups become deformed, age prematurely and fall out.</p> <p>▶ Store the suction cups according to the storage recommendations for elastomer parts.</p>

Storage recommendation for elastomer parts

The effects of ozone, light (especially UV), heat, oxygen, humidity as well as mechanical influences can reduce the service life of rubber products. Rubber parts should therefore be stored in a cool place (0° C to + 15° C, max. 25° C) that is dark, dry, low in dust and offers protection from the weather, ozone and drafts. They should also be free of tension (e.g. stacked appropriately to avoid deformation).

Make sure that there is no condensation inside the reservoir (sight glass item 18). Drain condensation if necessary (see section 9.7).

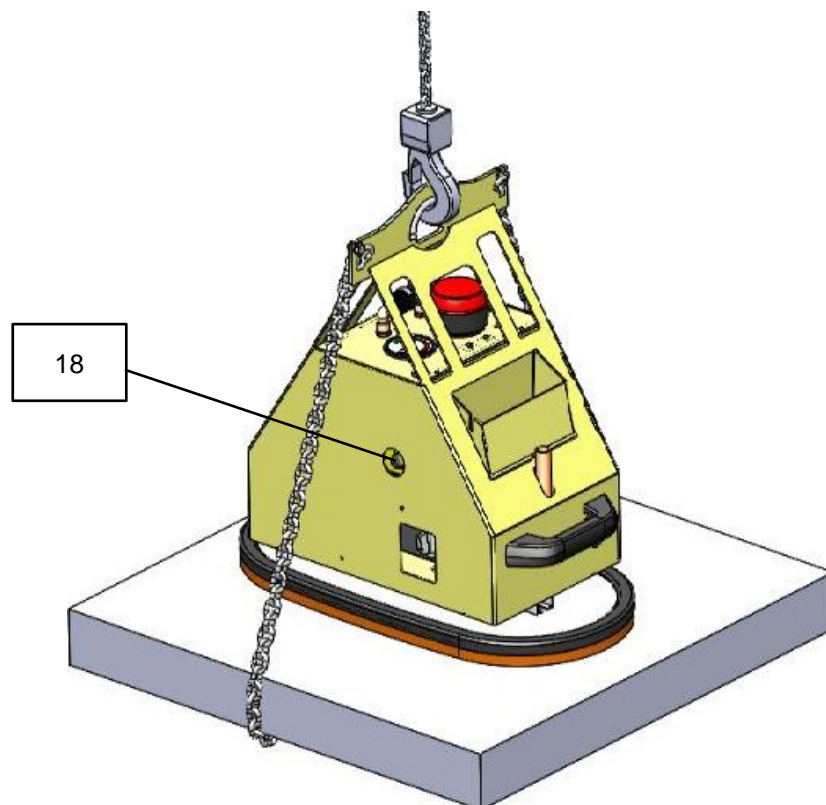

8 Troubleshooting

The lifting device may only be installed and maintained by qualified specialist personnel and mechanics. See section 1.10 Operator duties.



After carrying out repair and maintenance work, always inspect the safety features as outlined in section “9.5 Inspecting safety features.”



If the **load cannot be lifted**, work through the following list to identify and rectify the problem.



Problem	Cause	Solution
Vacuum generation is not operational	Battery is empty or defective	Charge or replace battery (see section 9.2)
	Plug connector not connected to the battery	Connect plug adapter
Vacuum generation in process, vacuum of -0.6 bar has not been reached	Sealing lip on suction plate is damaged	Replace suction plate
	Load has cracks, gaps or is porous	Load can not be handled with this lifting device
	Gauge is faulty	Replace the gauge
	Leaking hose/screw unions	Replace/seal components
	Vacuum switch misaligned/faulty	Contact customer service
	Filter is dirty	Blow filter out or replace
	Filter not closed	Close filter
	Leaking hose/screw unions	Replace/seal components
Vacuum generation in progress, suction not present	Switch on/off switch to position “I” (only one vacuum pump running)	Switch on/off switch to position “II” (two vacuum pumps running)
	Manual slide valve is in “Release” position	Move manual slide valve to “Apply suction to load” position
Light is flashing, vacuum is falling below -0.48 bar.	Manual slide valve faulty	Contact customer service
	Load has cracks, gaps or is porous	Load can not be handled with this lifting device
	Sealing lip is damaged	Replace suction plate
	Faulty hose/leaking screw unions	Replace components
	Vacuum switch misaligned/faulty	Contact customer service

9 Maintenance

9.1 General notes

The lifting device may only be installed and maintained by qualified specialist personnel and mechanics. See section 1.10 Operator duties.

 WARNING	
	<p>Risk of injury due to system maintenance by untrained personnel Serious injury may result</p> <p>▶ The system may be maintained only by trained personnel who have read and understood the operating and maintenance instructions.</p>

 WARNING	
	<p>Risk of injury from worn, unmaintained parts Worn and unmaintained parts can cause damage, resulting in failure of the lifting device and potentially causing severe injury.</p> <p>▶ Observe the operating, maintenance and servicing requirements specified in these operating and maintenance instructions.</p>

9.2 Replace battery

If the battery life decreases, it must be replaced.

Procedure:

1. Switch off device.
2. Open device cover (using a large flathead screwdriver).
3. Disconnect connecting tube.
4. Remove battery.
5. Attach pin cable to the new battery.
 Pay attention to the correct polarity:
 RED = POSITIVE
 BLACK = NEGATIVE
6. Insert battery.
7. Attach connecting tube.
8. Close device cover and lock with screwdriver.
9. Properly dispose of used battery.



9.3 Vacuum generator

See enclosed vacuum pump operating instructions / (Appendix).

9.4 Suction plates/sealing lips

- Remove stuck objects and debris such as sand, stone particles, dust, etc. from sealing lips at least once a week.
- Clean foam rubber with compressed air and/or water jet or soap water.
- Replace damaged or worn suction plates immediately (cracks, holes, corrugation).
- Always replace suction plates completely.



Tip:
Heating the screw union of the suction plate makes it easier to loosen.

Seal the suction plate connection again when screwing in.

9.5 Inspecting safety features

Inspect the safety features (see section 2.6) at the start of every shift (if the device is not operated continuously) or once a week (if operated continuously).

9.5.1 Inspect flashing light

Switch on the vacuum generator.

Place the lifting device on a workpiece with a dense, smooth surface and apply suction to load.

 WARNING	
	<p>Danger from falling load in the event of vacuum failure</p> <p>The load may come loose and fall off during inspection.</p> <p>▶ Only apply suction to the load. Do not lift.</p>

Lift the sealing lip of the suction plate slightly when the vacuum is building to simulate a leak. The vacuum shown on the gauge will decrease. The light flashes when the vacuum falls below -0.43 bar.

 WARNING	
	<p>Risk of injury from falling objects</p> <p>▶ Turn on the vacuum switch prior to work and do not ever adjust.</p>

9.5.2 Inspecting suction hoses and clamps

Check that all suction hoses and hose clamps are securely fastened, tighten if necessary.

9.5.3 Check airtightness

Carry out a leak test once a month.

9.5.3.1 Leak test of the suction plate

1. Place the device with the suction plate on a dense and flat surface (e.g. steel plate).
2. Switch on the vacuum.
3. Wait until the required vacuum is reached (the device switches off automatically at approx. -0.66 bar).
4. Lift the sucked load (steel plate) a little (20-30 cm).
→ The load **must not fall down** during the leak test!
If the vacuum decreases and the vacuum pump can build up the required vacuum again by pumping, the suction plate can be used!
5. After the test, place the load on the floor and remove it (manual slide valve →).

 WARNING	
	<p>Danger from falling load in the event of vacuum failure</p> <p>The load may come loose and fall off during inspection.</p> <p>▶ Lift load only 20-30 cm and move feet out of danger zone.</p>

9.5.3.2 Leak test of the device (without suction plate)

1. Remove the vacuum hose from the suction plate.
2. Switch on the vacuum pump.
3. Seal the opening of the vacuum hose (e.g. with your thumb).
4. Wait until the required vacuum is reached (the device switches off at approx. -0.66 bar).
5. Switch off the vacuum pump. The vacuum may fall by a maximum of **0.1 bar** within **5 minutes**.

Rectify any faults before starting the device. Should faults occur during operation, switch off the device and rectify the faults.

9.6 Filter

Inspect dirt filter at least once a week. Replace filter if it is extremely dirty.

Procedure:

1. Open unit cover.
2. Disconnect hose clamp and remove filter.
3. Insert new filter and attach with hose clamp.
4. Close the unit cover again.
5. Check airtightness (see above).

9.7 Drain condensation

Vacuum generation produces condensation due to humidity. Condensation must be drained at least once a day. Inspect sight glass (18) as necessary.

Procedure:

1. Park the device on even ground.
2. Switch off the vacuum generator.
3. Open blow off valve (item 17) and drain condensation.
4. Close the drain valve.



When the load is lifted, the drain valve (17) must NOT be opened. Otherwise there is a risk of accident, if the load falls down!!

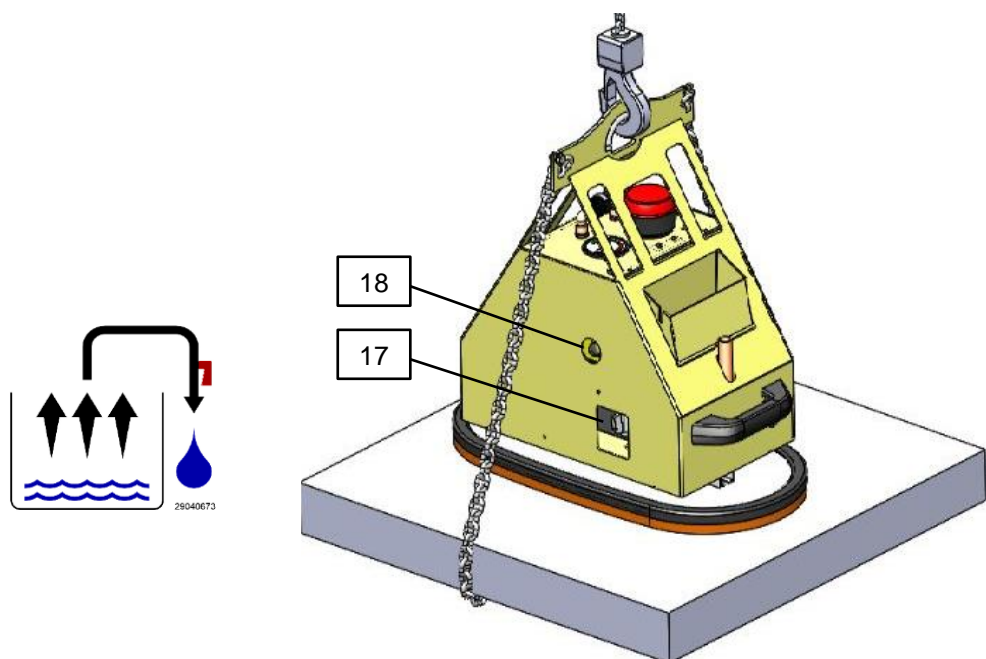

9.8 Maintenance schedule

9.8.1 Mechanics



The below-mentioned intervals should be reduced during heavy use.

Interval	Work to be completed
Initial inspection after 25 hours of use	Check and tighten all fastening screws (this may only be carried out by a specialist).
Every 50 hours of use	Tighten all fastening screws (make sure the screw are tightened according to the valid tightening torque values of the associated strength grades). Check that all joints, guides, bolts and gear wheels (if available) are functioning properly. Adjust or replace as needed.

9.8.2 Remaining components



The yearly inspection must be completed by a specialist (see section o).

	Interval				
	Daily	Weekly	Monthly	Every six months	Yearly
Check safety features: - Gauge OK? - Does warning device trip at correct low/excess pressure values?	X				X
Inspect filters, replace if required		X			X
Check battery charging status (display item 7).	X				X
Replace battery if required.					X
Are the vacuum hoses in good condition (not brittle, not kinked, no worn sections and no leaks)?			X		X
Are all connections (hose clamps, etc.) secure?				X	X
Are type, load capacity and warning signs in complete and legible condition?					X
Are the operating and maintenance instructions still available and are operators familiar with them?					X
Inspect all load-bearing parts (e.g. suspension, bolts, brackets, etc.). Inspect for cracks, deformities, wear, corrosion, functional reliability and other damage.					X
Clean suction plate / Inspect for cracks, evenness of sealing lip, etc. Replace if necessary		X			X
Has the test label been updated?					X

	Interval				
	Daily	Weekly	Monthly	Every six months	Yearly
General condition of the device					X
Leak test			X		X
Drain condensation	X				X
Check the condition of the load-securing chain 1)					X

1) Once the load has been held by the load securing chain, the load securing chain must be properly tested and replaced if necessary. Damaged load-securing chains must not be used any further!!

9.9 Annual inspection

- ▶ It is the contractor's responsibility to ensure that the device is checked by an expert in periods of max. 1 year and all recognized errors are removed (→ see DGUV regulation 1-54 and DGUV norm 100-500).
- ▶ The corresponding legal regulations and the regulations of the declaration of conformity must be observed!
- ▶ The expert inspection can also be done by the manufacturer Probst GmbH. Contact us at: service@probst-handling.de
- ▶ We recommend affixing the inspection sticker "„Sachkundigenprüfung / Expert inspection" in a clearly visible place (order no.: 2904.0056+Tüv sticker with year number) after the inspection has been done.



The specialist inspection must be documented.

Device	Year	Date	Specialist	Company

9.10 Cleaning

Only use cold cleaner to clean the lifting device. (Do not use mineral spirits or corrosive liquids. This causes leaks or irreparable damage to the hoses.) The suction plates can be cleaned using soap and warm water. Do not use cleaning solvents on the suction sealing lips.

9.11 Spare parts

We offer a warranty for original spare parts supplied by Probst GmbH only.

Probst GmbH is not liable for any damage resulting from the use of non-original spare parts or accessories.

When ordering spare parts, please specify the order number, serial number of the lifting device and part number of the part (see the type plate and replacement parts list).

10 Decommissioning and Disposal

The lifting device may only be decommissioned and prepared for disposal by qualified specialists.

Procedure:

1. Disconnect lifting device from transportation or other lifting device.
2. Discharge battery and dispose of properly (see section 9.2).
3. Detach and dispose of the suction cups.
4. Release the hose clamps and remove the hoses.
5. Detach and dispose of the base body.

For proper disposal, please contact a company specializing in the disposal of technical goods and instruct the company to observe current disposal and environmental regulations.

The manufacturer of the device will be happy to assist you in finding a suitable company.

Proof of maintenance



Warranty claim for this machine only apply for performance of the mandatory maintenance works (by an authorised specialist workshop)! After each completed performance of a maintenance interval the included form must be fill out, stamped, signed and send back to us immediately. ¹⁾

¹⁾ via e-mail to service@probst-handling.de / via fax or post

Operator: _____
 Device type: _____ Article -No.: _____
 Device-No.: _____ Year of make: _____

First inspection after 25 operating hours		
Date:	Maintenance work:	Inspection by company:
		Company Stamp
	
		Name / Signature

All 50 operating hours		
Date:	Maintenance work:	Inspection by company:
		Company Stamp
	
		Name / Signature
		Inspection by company:
		Company Stamp
	
		Name / Signature
		Inspection by company:
		Company Stamp
	
		Name / Signature

Minimum 1x per year		
Date:	Maintenance work:	Inspection by company:
		Company Stamp
	
		Name / Signature
		Inspection by company:
		Company Stamp
	
		Name / Signature

**SM-600-GREENLINE / SM-600-GREENLINE-Power
SM-600-GREENLINE-POWER-FFS**



FR | Instructions d'emploi

1	Instructions de sécurité.....	4
1.1	Classification des consignes de sécurité.....	4
1.2	Signaux d'avertissement.....	5
1.3	Signaux d'obligation.....	5
1.4	Signalisation de sécurité.....	6
1.5	Destination de cette notice.....	7
1.6	Consignes de sécurité générales.....	7
1.7	Sécurité en cours de fonctionnement.....	9
1.7.1	Généralités.....	9
1.8	Dangers particuliers.....	10
1.9	Utilisation conforme.....	10
1.10	Obligations de l'exploitant.....	12
1.11	Exigences concernant le lieu d'installation / le poste de travail.....	13
1.11.1	Exigences concernant le lieu d'installation.....	13
1.11.2	Exigences concernant le poste de travail.....	14
1.12	Définition de la zone de danger.....	14
1.13	Émissions.....	16
1.14	Équipement de protection personnel.....	17
1.14.1	Installation/mise hors service et élimination de l'engin de levage.....	17
1.14.2	Maniement de l'engin de levage.....	17
1.14.3	Élimination des pannes / maintenance de l'engin de levage.....	17
2	Description du produit.....	18
2.1	Composants.....	18
2.2	Éléments de commande.....	20
2.3	Plaque signalétique.....	21
2.4	Générateur de vide.....	21
2.5	Platines d'aspiration.....	21
2.6	Dispositifs de sécurité.....	21
3	Données techniques.....	22
3.1	Données techniques pour télécommande (seulement SM-600-POWER-FFS).....	22
4	Livraison, emballage et transport.....	23
4.1	Livraison.....	23
4.1.1	Volume de la livraison.....	23
4.1.2	Contrôler que la livraison est complète.....	23
4.1.3	Déclarer les dommages.....	23
4.2	Emballage.....	23
4.3	Transport.....	23
4.4	Retrait de l'engin de levage de la palette.....	24
5	Mise en service.....	25
5.1	Liste d'outils.....	25
5.2	Accrocher l'engin de levage.....	25
5.3	Montage de la platine d'aspiration sur l'engin de levage.....	25
5.4	Remplacement de la platine d'aspiration.....	27

5.5	Alimentation en énergie.....	27
6	Exploitation.....	28
6.1	Consignes de sécurité générales pour l'exploitation.....	28
6.2	Contrôles avant le début du travail.....	30
6.3	Comportement en cas d'urgence.....	30
6.4	Option télécommande radio.....	31
6.5	Soulever la charge, aspirer.....	31
6.6	Guider la charge.....	33
6.7	Déposer la charge, la détacher.....	34
6.8	Garer l'engin de levage.....	35
7	Entreposage.....	36
8	Dépannage.....	37
9	Maintenance.....	38
9.1	Remarques générales.....	38
9.2	Remplacer l'accu.....	38
9.3	Générateur de vide.....	38
9.4	Platines d'aspiration / lèvres d'étanchéité.....	39
9.5	Contrôler les dispositifs de sécurité.....	39
9.5.1	Contrôler la lampe éclair.....	39
9.5.2	Contrôler les flexibles d'aspiration et les brides de fixation.....	39
9.5.3	Contrôler l'étanchéité.....	40
9.6	Filtre.....	40
9.7	Évacuer l'eau de condensation.....	40
9.8	Plan de maintenance.....	41
9.8.1	Mécanique.....	41
9.8.2	Autres éléments de construction.....	41
9.9	Nettoyage.....	43
9.10	Pièces détachées.....	43
10	Mise hors service et élimination.....	43

CE-Déclaration de Conformité

Description: Aimant en pierre SM
Type: SM-600-GREENLINE / SM-600-GREENLINE-Power SM-600-
GREENLINE-POWER-FFS

N° de commande: 52720006 / 52720007 / 52720008

Fabricant: Probst GmbH
Gottlieb-Daimler-Straße 6
71729 Erdmannhausen, Germany
info@probst-handling.de
www.probst-handling.com



La machine décrite ci-dessus est conforme aux exigences applicables des directives UE suivantes :

Idée directrice EC 2006/42/CE

Les normes et spécifications techniques suivantes ont été utilisées:

DIN EN ISO 12100

Sécurité des machines – Principes généraux de conception – Appréciation du risque et réduction du risque
2014/30/EU (Compatibilité électromagnétique)

DIN EN ISO 13857

Sécurité des machines — Distances de sécurité empêchant les membres supérieurs et inférieurs d'atteindre les zones dangereuses.

DIN EN 1012-1 / DIN EN 1012-2

Compresseurs et pompes à vide ; Prescriptions de sécurité, parties 1 et 2.

DIN EN 60204-1 (IEC 60204-1)

Sécurité des machines, équipement électrique des machines industrielles. Partie 1 : Exigences générales

Personne autorisée pour EC-documentation:

Nom: Jean Holderied

Adresse: Probst GmbH; Gottlieb-Daimler-Straße 6; 71729 Erdmannhausen, Germany

Signature, informations ou signataire :

Erdmannhausen, 05.03.2024.....

(Eric Wilhelm, Directeur général)

1 Instructions de sécurité

1.1 Classification des consignes de sécurité

Danger

Ce signal avertit d'un danger pouvant entraîner la mort ou de graves blessures si on ne l'évite pas.

 DANGER	
	Nature et source du danger Conséquence du danger ▶ Remède au danger

Avertissement

Ce signal avertit d'un danger pouvant entraîner la mort ou de graves blessures si on ne l'évite pas.

 AVERTISSEMENT	
	Nature et source du danger Conséquence du danger ▶ Remède au danger

Attention

Ce signal avertit d'un danger pouvant entraîner des blessures si on ne l'évite pas.

 ATTENTION	
	Nature et source du danger Conséquence du danger ▶ Remède au danger











Attention

Ce signal avertit d'un danger pouvant entraîner des dommages matériels si on ne l'évite pas.

ATTENTION	
	Nature et source du danger Conséquence du danger ▶ Remède au danger







1.2 Signaux d'avertissement

Explication des signaux d'avertissement utilisés dans les notices d'emploi et de maintenance.

Signal d'avertissement	Description	Signal d'avertissement	Description
	Avertissement général		Avertissement d'une atmosphère explosive
	Avertissement d'un risque de blessures aux mains		Avertissement d'éléments volant dans l'air
	Avertissement d'une charge suspendue		Avertissement d'un risque de pincement
	Avertissement d'un vide d'air		Avertissement d'un risque de chute
	Avertissement de possibles chutes d'éléments		Avertissement de risques pour l'ouïe

1.3 Signaux d'obligation

Explication des signaux d'obligation utilisés dans les notices d'emploi et de maintenance.

Signaux d'obligation	Description	Signaux d'obligation	Description
	Utiliser une protection auditive		Utiliser des chaussures de sécurité
	Utiliser une protection pour les mains		Retirer la fiche réseau
	Respecter la notice d'emploi		Utiliser une protection pour les yeux

1.4 Signalisation de sécurité

PANNEAUX D'INTERDICTION

Symbole	Signification	Réf.	Taille
	Ne jamais se placer sous une charge suspendue. Danger de mort !	2904.0210 2904.0209 2904.0204	Ø30 mm Ø50 mm Ø80 mm
	La charge aspirée ne doit jamais être soulevée et transportée sans fixation supplémentaire par la chaîne d'arrimage.	2904.0767	55 x 25 mm
	Ne jamais saisir d'objet de manière excentrée (toujours les saisir en leur milieu).	2904.0383 2904.0594	102 x 52 mm 65 x 33 mm

PANNEAUX D'AVERTISSEMENT

Symbole	Signification	Réf.	Taille
	Risque d'écrasement des mains.	2904.0221 2904.0220 2904.0107	30 x 30 mm 50 x 50 mm 80 x 80 mm
	Référence à l'appareil radio télécommandé (optionnelles)	2904.0647	130 x 50 mm

PANNEAUX OBLIGATION

Symbole	Signification	Réf.	Taille
	Chaque opérateur doit avoir lu et assimilé la notice d'instructions de l'appareil, ainsi que les règles de sécurité.	2904.0665 2904.0666	Ø 30 mm Ø 50 mm
	Les chaînes de sécurité doivent être bien tendues autour de la charge. Les chaînes de sécurité ne doivent jamais pendre simplement sous la charge !	2904.0690 2904.0689 2904.0688	25 x 55 mm 70 x 41 mm 146 x 85 mm
	Retirez le tuyau d'aspiration avant de changer la plaque d'aspiration.	2904.0322	65 x 88 mm

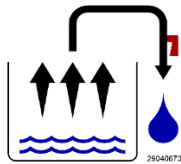

Vidangez l'eau de condensation de l'appareil tous les jours.

2904.0673

40 x 40 mm

NOTE SIGN

Symbole	Signification	Réf.	Taille
<p>(optionnelles)</p>	Aspiration et dégagement de la charge	2904.0320	25 x 60 mm

1.5 Destination de cette notice

AVERTISSEMENT	
	<p>Risque d'accident en cas de non-respect des consignes</p> <ul style="list-style-type: none"> ▶ Cette notice d'emploi et de maintenance est partie intégrante des engins de levage Steinmagnet «Standard» et «Power» et contient des informations importantes pour leur utilisation. ▶ La notice d'emploi et de maintenance est adaptée à la livraison de l'entreprise Probst. Des modifications du système effectuées par le client ne sont pas prises en considération et sont formellement interdites. ▶ L'utilisation, le raccordement et la mise en service ne doivent être effectués qu'une fois que cette notice d'emploi et de maintenance a été lue et comprise.



1.6 Consignes de sécurité générales

	<p>L'engin de levage de la série STEINMAGNET, nommé engin de levage dans ce qui suit, est construit selon l'état de la technique le plus récent et présente un fonctionnement sûr dans la mesure où les dispositions figurant dans cette notice sont respectées. Une manipulation incorrecte de l'engin de levage peut engendrer des risques.</p>
--	----------------------------------------------------------------------------------------------------------------------------------------------------------------------------------------------------------------------------------------------------------------------------------------------------------------------------------------------------------

AVERTISSEMENT	
	<p>Risque d'accident en cas de non-respect des consignes de sécurité générales</p> <ul style="list-style-type: none"> ▶ N'utiliser que les possibilités de raccordement, les perçages et les moyens de fixation qui sont prévus. ▶ Le montage et le démontage ne sont autorisés qu'en l'absence de pression. ▶ Lors de travaux sur l'engin de levage, l'opérateur doit faire en sorte qu'aucun accès au moyen de transport ou de levage utilisé (grue, palan à chaîne, engin de chantier, ...) ne soit possible, de manière à ce qu'aucun mouvement ne puisse avoir lieu.

	<ul style="list-style-type: none"> ▶ Les travaux d'installation, de maintenance et de réparation ne doivent être effectués que par un personnel et des mécaniciens qualifiés s'il leur est possible, en raison de leurs connaissances et de leurs expériences ainsi que de la connaissance des dispositions applicables, de juger des travaux qui leur sont confiés, de discerner d'éventuels dangers et de prendre les mesures de sécurité appropriées ! ▶ Les règlements généraux de sécurité et les normes EN doivent être pris en considération et respectés ! ▶ Les personnes et les animaux ne sont pas autorisés à séjourner dans la zone de danger ! ▶ L'engin de levage ne doit être utilisé que conformément à sa destination (chapitre « Utilisation conforme »). ▶ Seules des charges appropriées peuvent être soulevées et transportées avec l'engin de levage. ▶ Vous êtes coresponsables vis-à-vis de tiers dans la zone de travail de l'engin de levage, c'est pourquoi les compétences concernant les diverses activités sur le système doivent être clairement fixées et respectées. Les compétences ne doivent comporter aucune obscurité. ▶ À aucun moment, l'engin de levage ne doit aspirer de liquide ou de matières en vrac. ▶ Les éléments de construction doivent être de manière générale protégés contre les détériorations de toute nature !
--	----------------------------------------------------------------------------------------------------------------------------------------------------------------------------------------------------------------------------------------------------------------------------------------------------------------------------------------------------------------------------------------------------------------------------------------------------------------------------------------------------------------------------------------------------------------------------------------------------------------------------------------------------------------------------------------------------------------------------------------------------------------------------------------------------------------------------------------------------------------------------------------------------------------------------------------------------------------------------------------------------------------------------------------------------------------------------------------------------------------------------------------------------------------------------------------------------------------------------------------------------------------------------------------------------------------------------------------------------------------------------------------------------------------------------------------------------------------

 **AVERTISSEMENT**

 	<p>Risque d'accident en cas de non-respect des consignes de sécurité générales</p> <p>Domages corporels / installations / systèmes</p> <ul style="list-style-type: none"> ▶ Les limites de charge admissibles sont définies au chapitre Données techniques et ne doivent pas être dépassées par le haut ou par le bas. ▶ Les dispositifs de sécurité doivent être dans un état irréprochable et mis en circuit pour le processus.
-------------------------------------------------------------------------------------------------------------------------------------------------------------------------	------------------------------------------------------------------------------------------------------------------------------------------------------------------------------------------------------------------------------------------------------------------------------------------------------------------------------------------------------------------------------------------------------------------------------------------------------------------

 **AVERTISSEMENT**

	<p>Risque de blessures dû à des points d'aspiration non couverts</p> <ul style="list-style-type: none"> ▶ Ne pas approcher les yeux ou les oreilles des points d'aspiration ou rapprocher ceux-ci d'autre part d'orifices corporels et ne pas y introduire les doigts. ▶ L'engin produit un très fort courant d'aspiration, capable d'aspirer cheveux et vêtements.
-------------------------------------------------------------------------------------	----------------------------------------------------------------------------------------------------------------------------------------------------------------------------------------------------------------------------------------------------------------------------------------------------------------------------------------------------------------------------------------------------

 **Conformez-vous constamment à toutes les lois et à tous les règlements en vigueur.**

Lors de l'utilisation de l'engin de levage, il est obligatoire de respecter au lieu d'utilisation les règlements légaux, les consignes de sécurité, les normes et les directives.

On se renseignera à leur sujet auprès des autorités compétentes.

Les consignes de sécurité figurant dans la présente notice d'emploi et de maintenance ne les annulent pas, mais doivent être considérées comme un supplément.

1.7 Sécurité en cours de fonctionnement

1.7.1 Généralités



Interdiction

- ▶ Ne travailler avec l'engin qu'à proximité du sol.
En opération de levage : La charge aspirée doit être abaissée **immédiatement** après le levage (par ex. d'une palette ou d'un camion) **jusqu'à juste au-dessus du sol** (env. 20 - 30 cm). La charge est ensuite arrimée par la **chaîne de sécurité** et ne peut être transportée qu'ensuite sur le lieu de montage. Pour transporter la charge, ne la soulever qu'aussi haut que nécessaire (environ 0,5 m au-dessus du niveau du sol recommandé).
Il est interdit de faire passer l'engin au-dessus des personnes.



- ▶ Le guidage manuel n'est autorisé que sur les appareils équipés de poignées.
- ▶ Il est interdit à l'opérateur de quitter le poste de commande tant que l'appareil est sous charge ; il doit en outre toujours surveiller visuellement la charge.
- ▶ L'opérateur doit surveiller le manomètre en permanence. La charge (pavé par ex.) doit être soulevée **seulement** lorsque le vide nécessaire est atteint. Si l'aiguille du manomètre se déplace dans la zone rouge en dessous du vide nécessaire, **la charge doit être déposée immédiatement.**
Danger de mort – la charge va tomber !



Interdiction

- ▶ Pendant le fonctionnement de l'engin, le stationnement de personnes dans la zone de travail est interdit !
À moins qu'il ne soit indispensable. En raison de la nature de l'utilisation de l'appareil, comme le guidage manuel de l'appareil (sur les poignées).
- ▶ En règle générale, il est interdit de stationner sous une charge suspendue. **Danger de mort !**
- ▶ Ne jamais déplacer les charges obliquement ni les traîner sur le sol.
- ▶ Toujours saisir les charges au centre pour éviter les **risques de basculement.**
- ▶ Ne jamais aspirer la charge en dehors du centre, **risque de basculement.**
- ▶ Détacher la charge de la platine d'aspiration seulement quand elle repose entièrement et en toute sécurité sur le sol.



- ▶ **Attention aux doigts quand vous détachez la charge. Risque d'écrasement !**
- ▶ S'assurer que les largeurs d'ouverture/ grandeurs nominales et la charge admissible de l'appareil ne sont pas dépassées.



Interdiction

- ▶ Ne pas arracher de charges bloquées avec l'engin.
- ▶ Il est **interdit de secouer l'appareil vers le haut ou vers le bas** avec ou sans charge !
Les vibrations inutiles doivent être évitées. Tout comme la conduite rapide avec le porteur/le palan sur un terrain accidenté !
Danger de mort ou d'accident : La charge pourrait tomber ou endommager l'équipement de manutention de la charge ! **En général, ne roulez à vitesse de marche qu'avec la charge soulevée !**

1.8 Dangers particuliers





Interdiction







- ▶ Sécuriser la zone de travail sur un large périmètre pour éviter l'intrusion des personnes étrangères au chantier, **particulièrement aux enfants**.
- ▶ La zone de travail doit être suffisamment éclairée !
- ▶ Sur les lieux de travail, le manque d'ordre augmente les risques d'accident !
- ▶ Attention lorsque les paquets de matériaux de construction sont humides, souillés ou givrés !
- ▶ **Il est interdit de travailler avec l'appareil par des conditions météorologiques inférieures à 3 ° C (37,5° F). Risque de chute par glissement des produits préhensibles causé par l'humidité ou le givre.**
- ▶ Puisque la charge est retenue par les ventouses du dispositif à vide, elle tombe en cas de défaillance du système de production du vide (en cas de panne de courant, par ex.).
- ▶ Ceci peut se faire en cas d'une panne de la génération du vide. Dans ce cas un réservoir y monté maintient le vide pendant un court temps de sécurité (ce qui dépend de la densité de la surface de la pièce à usiner).
- ▶ Si possible, il faut déposer la charge tout-de-suite. Sinon éloignez-vous immédiatement de la zone de danger.
- ▶ Le dispositif produit une très forte succion qui peut aspirer les cheveux et les vêtements. Il ne faut pas regarder dans le branchement d'aspiration lorsque le dispositif fonctionne. Les yeux peuvent être aspirés. **Les yeux peuvent être aspirés.**

1.9 Utilisation conforme

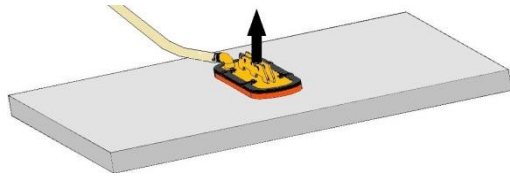
L'engin de levage sert à soulever et à transporter à proximité du sol (voir chapitre « Dangers particuliers ») des dalles en pierre plates, compactes et non poreuses de granit, de marbre, de wet cast, etc. ainsi que des éléments de béton, des pierres naturelles, des marches en grès, des tuyaux en grès-cérame, etc. (dans la mesure où l'on peut obtenir un vide de -0,6 bar) à l'aide de moyens de transport et de levage appropriés (grue, palan à chaînes, véhicule de chantier, ...).

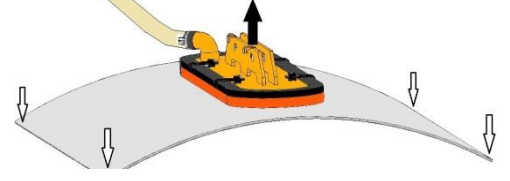
 AVERTISSEMENT	
	<p>Danger dû à la chute d'objets en raison de l'utilisation d'une platine d'aspiration non appropriée.</p> <ul style="list-style-type: none"> ▶ La platine d'aspiration ne fait pas partie de la livraison. L'exploitant doit s'assurer que seules sont utilisées des platines d'aspiration convenant à la charge à soulever. Charge maximale admissible 600 kg. ▶ La fixation de la platine d'aspiration doit répondre aux exigences mentionnées au chapitre 5.3. D'autres fixations de platines d'aspiration ne sont pas autorisées. ▶ La surface d'aspiration de la charge à soulever doit être étanche à l'aspiration, c'est-à-dire que la charge saisie doit encore être maintenue 5 minutes après coupure de l'alimentation en énergie. On doit le cas échéant s'en assurer par des essais.

<ul style="list-style-type: none"> ▶ La charge (dalle en pierre) qui doit être aspirée et transportée doit avoir une stabilité suffisante, dans le cas contraire la charge risque de se briser au moment où elle sera soulevée! ▶ Les dalles de pierre ne doivent en aucun cas fléchir pendant l'opération de levage – il faut faire particulièrement attention avec les dalles en pierre peu épaisses ou de grand format! 		
<ul style="list-style-type: none"> ▶ En général, les charges (dalles de pierre) ne peuvent être aspirées qu'en position centrale, sinon la charge sera suspendue de travers sur l'appareil, ce qui peut entraîner la rupture de la charge en particulier lors du levage de dalles de pierre de grand format avec une petite platine d'aspiration. ▶ Les platines d'aspiration standard ne sont pas adaptées pour transporter des vitres! 		

 DANGER	
	<p style="text-align: center;">Les platines d'aspiration ont des capacités de charge différentes</p> <p>Danger: tomber de la charge (dalle) !</p> <ul style="list-style-type: none"> ▶ Quelques-unes des platines d'aspiration qui peuvent être installées sur l'appareil diminuent sa capacité de charge. <i>La charge admissible maximale est indiquée sur chaque platine d'aspiration.</i> <p style="text-align: center;">Utilisez uniquement les plaques aspirantes adaptées à l'appareil!</p> <p style="text-align: center;">Seules peuvent être utilisées les platines d'aspiration du fabricant PROBST !</p> <ul style="list-style-type: none"> ▶ N'excédez pas la charge admise des plaques aspirantes !!! Danger: tomber de la charge (dalle) !

	<p>L'engin de levage est livré sans platine d'aspiration.</p> <p>Le client a l'obligation d'exécuter une procédure d'évaluation de la conformité, conformément à l'article 12 de la directive relative aux machines 2006/42 (voir également chapitre 5.3).</p>
-------------------------------------------------------------------------------------	----------------------------------------------------------------------------------------------------------------------------------------------------------------------------------------------------------------------------------------------------------------

Les limites de charge admissibles sont définies au chapitre 3 (Données techniques) et ne doivent pas être dépassées par le haut ou par le bas. Tenez également compte à ce sujet de la plaque signalétique ou de l'autocollant capacité de charge !

L'engin de levage ne doit pas être transformé ou modifié du fait d'une initiative privée. Il ne doit être exploité que dans son état originel de livraison.

AVERTISSEMENT	
	<p>Il existe un risque que des parties du corps soient écrasées ou des personnes assommées par la chute de la charge.</p> <p>Les transformations et modifications effectuées de son propre chef font perdre à l'engin de levage l'intégrité nécessaire. Son fonctionnement ne peut plus être garanti.</p> <p>▶ N'entreprendre aucune modification du système côté client.</p>

AVERTISSEMENT	
	<p>Danger de mort dû à une chute lors de l'utilisation comme moyen de transport pour homme et animal ou comme aide à la montée.</p> <p>Fractures, blessures gravissimes ou mort en sont la conséquence.</p> <p>▶ L'utilisation de l'engin de levage comme aide à la montée ou comme moyen de transport pour homme et animal est interdite !</p>

1.10 Obligations de l'exploitant

L'engin de levage ne doit être installé, entretenu et réparé que par des spécialistes et mécaniciens qualifiés.



Est spécialiste celui qui en raison de sa formation professionnelle, de ses connaissances et de ses expériences ainsi que de sa connaissance des dispositions applicables, peut juger des travaux qui lui sont confiés, discerner les éventuels dangers et prendre les mesures de sécurité appropriées. Un spécialiste doit respecter les règles applicables spécifiques à sa spécialité.



L'entreprise de l'utilisateur doit garantir par des mesures internes à l'entreprise que toute personne chargée dans l'entreprise de l'utilisateur de l'installation, de la mise en service, de la manipulation, de la maintenance et de la réparation de l'engin de levage n'emploie que des assurés,

- qui ont 18 ans révolus, qui sont aptes à leur tâche physiquement et intellectuellement,
- qui ont reçu une instruction concernant la conduite ou la maintenance de l'engin de levage,
- qui ont lu et compris la notice d'emploi et de maintenance,
- et dont on peut escompter qu'ils rempliront de manière fiable les tâches qui leur ont été confiées.

La notice d'emploi et de maintenance doit être accessible à tout moment et conservée pour des fins ultérieures.

! AVERTISSEMENT	
 	<p>Risque de blessure dû à un mauvais usage ou à la non observation des avertissements et des consignes de sécurité.</p> <ul style="list-style-type: none"> ▶ Utilisation uniquement par un personnel formé. ▶ Réglementation des pauses conformément aux dispositions locales pour éviter des accidents dûs à l'inattention.

- Le fonctionnement et l'état de l'engin de levage doivent être contrôlés avant chaque utilisation (voir chapitre 0).
- La maintenance, la lubrification et l'élimination des pannes doivent être effectuées seulement sur un engin de levage mis à l'arrêt !
- Dans le cas de défauts concernant la sécurité, l'engin de levage ne peut être réutilisé qu'après l'élimination complète de ses défauts.
- Dans le cas de fissures sur les parties portantes, l'engin de levage doit être aussitôt soustrait à toute utilisation.
- La notice d'emploi pour l'engin de levage doit pouvoir être consultée à tout moment sur le lieu d'utilisation.
- La plaque signalétique apposée sur l'engin de levage ne doit pas être enlevée.
- Les panneaux de signalisation illisibles doivent être remplacés.

1.11 Exigences concernant le lieu d'installation / le poste de travail

1.11.1 Exigences concernant le lieu d'installation

! DANGER	
	<p>Éléments de commande non protégés contre les explosions</p> <p>Danger d'incendie et d'explosion</p> <ul style="list-style-type: none"> ▶ L'engin de levage ne doit pas être utilisé dans des zones exposées aux explosions.

! AVERTISSEMENT	
	<p>Risque d'explosion par aspiration de substances inflammables</p> <ul style="list-style-type: none"> ▶ Avant la mise en place de l'engin de levage, s'assurer qu'aucune substance inflammable (carburants, solvants, etc.) ne peut être aspirée.

ATTENTION	
	<p>Détérioration de l'engin de levage due à un fonctionnement dans des zones à milieu acide ou basique ou bien à atmosphère polluée.</p> <ul style="list-style-type: none"> ▶ Avant utilisation dans un environnement à atmosphère agressive, consulter le fabricant.

L'engin de levage peut être utilisé à une température allant de 3°C à 40°C.

ATTENTION	
	<p>Détérioration de l'engin de levage due à une utilisation en dehors de la plage de température admissible</p> <ul style="list-style-type: none"> ▶ N'utiliser l'engin de levage qu'à la température ambiante admissible. ▶ Avant utilisation en dehors de la plage de température admissible, consulter le fabricant.

1.11.2 Exigences concernant le poste de travail

Le poste de travail de l'opérateur se situe au niveau de la poignée de maintien. S'assurer que l'opérateur peut surveiller en permanence la totalité du champ de travail. Le poste de travail doit être éclairé de manière suffisante et non éblouissante.

S'assurer par des instructions et des contrôles correspondants internes à l'entreprise que l'environnement du poste de travail est constamment propre et bien dégagé.

ATTENTION	
	<p>Détérioration de l'engin de levage par l'aspiration de petits accessoires</p> <ul style="list-style-type: none"> ▶ Le lieu d'utilisation et l'environnement de l'engin de levage doivent être exempts de petits accessoires aspirables.

1.12 Définition de la zone de danger

- La zone de danger est la zone située à l'intérieur ou autour d'un outil de travail dans laquelle la sécurité ou la santé des personnes qui s'y tiennent sont menacées ou pourraient l'être.
- Lorsque la charge est soulevée ou transportée, il est possible que la charge et l'engin de levage tombent par terre ou soient abaissés. C'est pourquoi la zone située directement sous l'engin de levage est une zone de danger.
- Lors du transport horizontal, il faut prendre en considération que le fait de soulever la charge, d'en accélérer ou d'en freiner le mouvement horizontal provoque par exemple un pivotement, une position en biais ou un mouvement pendulaire. C'est pourquoi l'environnement de la charge est une zone de danger.
- De ce fait, il est nécessaire de respecter également une distance de sécurité correspondante lors du guidage de la charge par l'accrocheur (toujours utiliser la poignée de maintien pour guider la charge).
- Ne pas marcher devant la charge : des obstacles inattendus peuvent constituer par exemple un risque de trébuchement et la charge se déplace dans votre direction. Également lorsqu'on stoppe le mouvement de déplacement horizontal, la charge oscille dans votre direction. Il est impossible d'observer / de surveiller en même temps le parcours et la charge.
- La zone de danger lors de la chute d'une charge dépend pour l'essentiel de la hauteur du transport et est difficile à évaluer. Les charges doivent par principe être maintenues aussi proches du sol que possible.



AVERTISSEMENT



Il y a risque de blessure dû à la chute d'objets quand

- la pression négative s'arrête
- la charge se détache en raison d'une collision
- les éléments de construction sont défailants par suite d'un chargement incorrect et d'une surcharge ou de modifications non autorisées.



Des personnes sont touchées ou blessées ou assommées !

- ▶ Sécuriser largement la zone de travail vis-à-vis des personnes non autorisées, en particulier des enfants.
- ▶ Avant chaque processus de transport, la charge doit être sécurisée à l'aide de la chaîne de sécurité pour charge.
- ▶ Il est interdit de se tenir sous une charge suspendue en l'air.
- ▶ Ne travailler que lorsque la totalité de la zone de travail est clairement visible.
- ▶ Faire attention aux autres personnes présentes dans la zone de travail.
- ▶ Ne jamais transporter une charge au-dessus des personnes.
- ▶ Le centre de gravité de la charge doit toujours se trouver dans la zone de travail de l'engin de transport ou de levage (grue, palan à chaîne, véhicule de chantier).
- ▶ Ne pas lâcher la poignée de maintien de l'engin de levage aussi longtemps qu'une charge est soulevée.
- ▶ L'opérateur / l'exploitant doit sécuriser la zone de travail. Les personnes ou les installations nécessaires à cet effet doivent être mises à disposition pendant le processus de levage / de transport.

1.13 Émissions



L'engin de levage émet des bruits et de l'air vicié.

Le niveau équivalent de bruit permanent généré par l'appareil se situe au-dessous de 70 dB(A).

 ATTENTION	
 	<p>Pollution sonore due au générateur de vide</p> <p>La pollution sonore peut entraîner des troubles auditifs.</p> <p>▶ Porter une protection auditive</p>

Les fluides aspirés sont vaporisés et dispersés par le générateur de vide. C'est pourquoi aucun air ambiant pollué ou contaminé (taille des particules 5µm au maximum) ne doit être aspiré.

 ATTENTION	
	<p>Risque d'intoxication dû à l'émission de gaz d'échappement aspirés.</p> <p>▶ Avant la mise en marche de l'engin de levage, s'assurer qu'aucun gaz d'échappement ne peut être aspiré.</p>

 ATTENTION	
	<p>Risque de blessure aux yeux</p> <p>Tous les générateurs de vide produisent un courant de ventilation. Cet air évacué peut contenir des particules en fonction de la pureté de l'air ambiant. Celles-ci sortent de l'orifice de ventilation à grande vitesse et peuvent blesser les personnes au visage et aux yeux.</p> <p>▶ Ne pas tourner le regard en direction du courant de ventilation.</p> <p>▶ Porter des lunettes de protection.</p>

1.14 Équipement de protection personnel

Portez constamment un équipement de protection adéquat !

1.14.1 Installation/mise hors service et élimination de l'engin de levage

- Chaussures de sécurité (selon la norme EN 20345 classe de sécurité S1 ou mieux)
- Gants de travail résistants (selon la norme EN 388 catégorie de sécurité 2133 ou mieux)
- Casque de chantier (selon la norme EN 397)
- Protection auditive (selon la norme EN 352 classe L ou supérieure)
- Autre équipement de protection adapté à la situation ou prescrit par les règlements nationaux.

1.14.2 Maniement de l'engin de levage

- Chaussures de sécurité (selon la norme EN 20345 classe de sécurité S1 ou mieux)
- Gants de travail résistants (selon la norme EN 388 catégorie de sécurité 2133 ou mieux)
- Casque de chantier (selon la norme EN 397)
- Autre équipement de protection adapté à la situation ou prescrit par les règlements nationaux.

1.14.3 Élimination des pannes / maintenance de l'engin de levage

- Chaussures de sécurité (selon la norme EN 20345 classe de sécurité S1 ou mieux)
- Gants de travail résistants (selon la norme EN 388 catégorie de sécurité 2133 ou mieux)
- Lunettes de protection (classe F)
- Protection auditive (selon la norme EN 352 classe L ou supérieure)
- Autre équipement de protection adapté à la situation ou prescrit par les règlements nationaux.

2 Description du produit

2.1 Composants

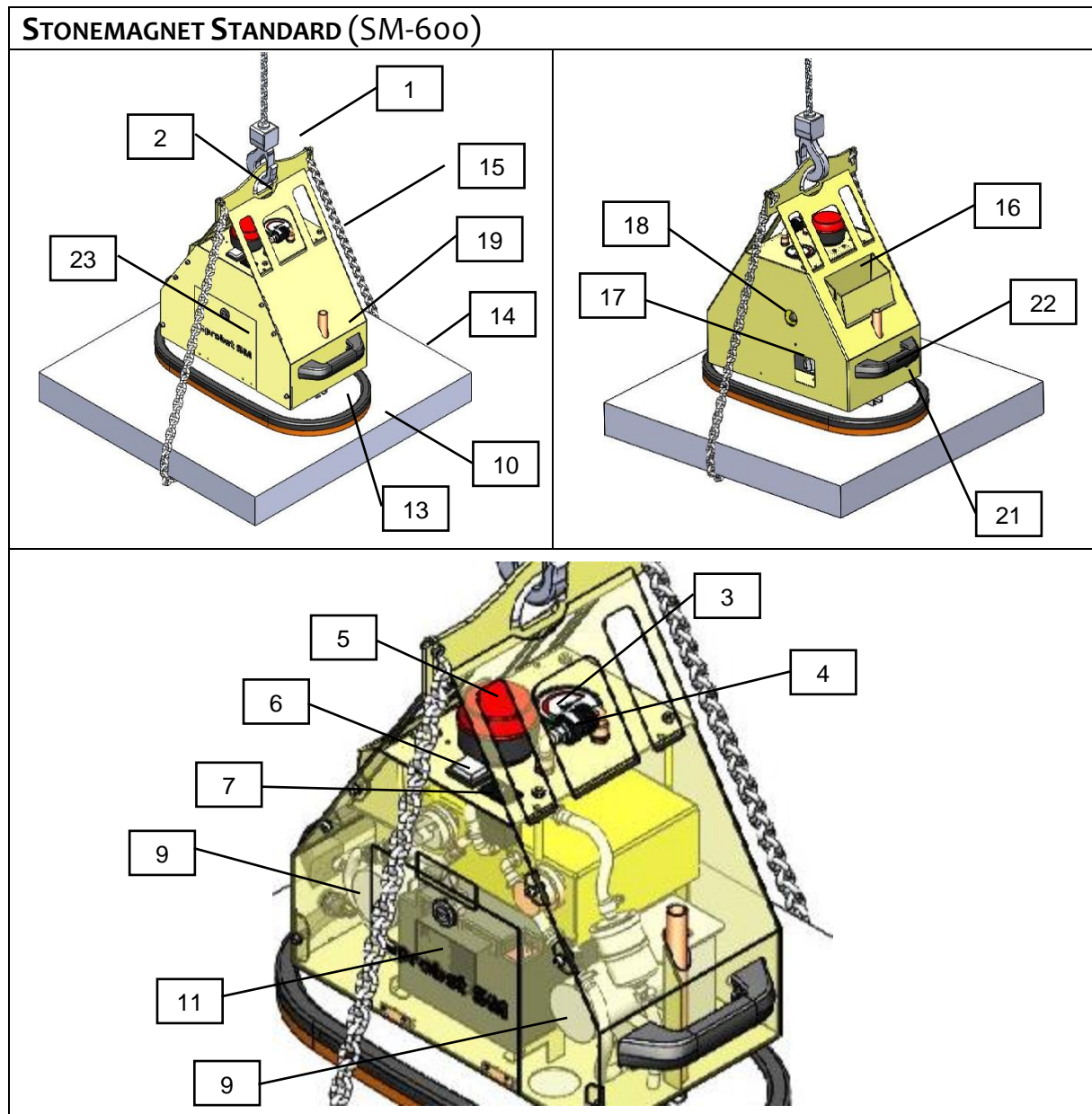

Pos.	Description	Pos.	Description
1	Crochet de grue	12	Filtre
2	Suspensions	13	Rail C de la ventouse #
3	Vacuomètre	14	Poids (Dalle)
4	Soupape à coulisse manuelle	15	Chaîne de sécurité pour charge
5	Lampe-flash rouge	16	Bac à chaîne
6	Interrupteur marche/arrêt (avec 3 positions)	17	Soupape de décharge
7	Indicateur d'état de charge accu	18	Verre de regard
8	Boîtier avec réservoir de sécurité	19	Perçage de fixation platine d'aspiration
9	Pompes à vide	21	Douille de chargement
10	Ventouse #	22	Poignée de maintien
11	Accumulateur	23	Couvercle de l'engin

(ne figure pas dans la livraison)

STONEMAGNET POWER (SM-600-POWER / SM-600-POWER-FFS)

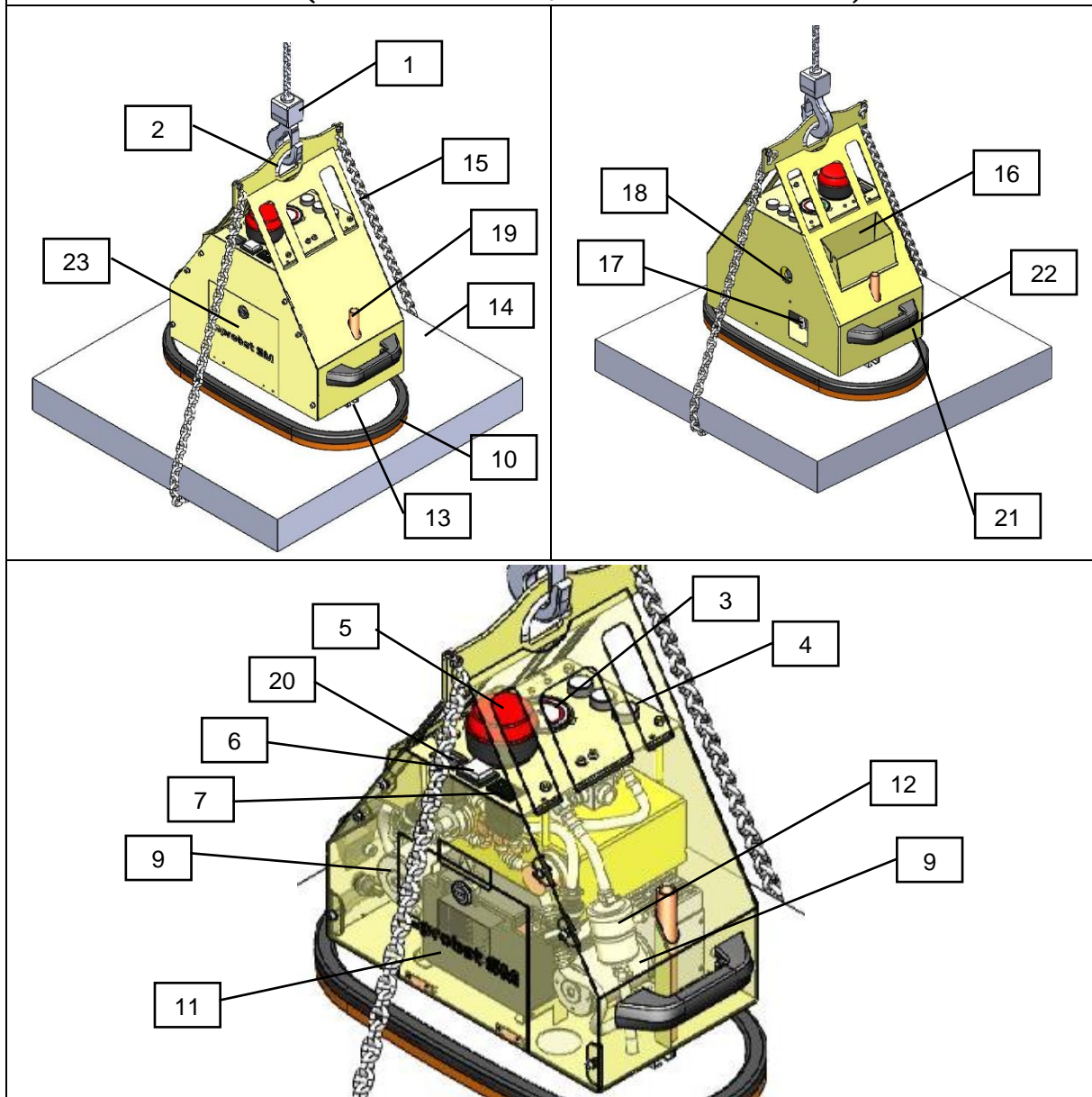



Pos.	Description	Pos.	Description
1	Crochet de grue	13	Rail C de la ventouse #
2	Suspensions	14	Poids (Dalle)
3	Vacuomètre	15	Chaîne de sécurité pour charge
4	Soupape à coulisse manuelle	16	Bac à chaîne
5	Lampe-flash rouge	17	Soupape de décharge
6	Interrupteur marche/arrêt (avec 3 positions)	18	Verre de regard
7	Indicateur d'état de charge accu	19	Perçage de fixation platine d'aspiration
8	Boîtier avec réservoir de sécurité	20	Compteur d'heures de service
9	Pompes à vide	21	Douille de chargement
10	Ventouse #	22	Poignée de maintien
11	Accumulateur	23	Couvercle de l'engin
12	Filtre		# (ne figure pas dans la livraison)

2.2 Éléments de commande

Stonemagnet Standard SM-600-POWER	Stonemagnet Power SM-600-POWER SM-600-POWER-FFS	
--------------------------------------	------------------------------------------------------	--

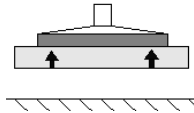

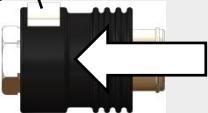
Aspirer la charge

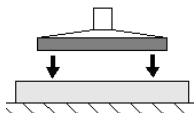

<p data-bbox="223 705 422 795">Bouton de blocage</p> 		<p data-bbox="1141 694 1380 728">Option télécommande</p> 
<p data-bbox="199 1075 805 1131">Pour déplacer la soupape coulissante manuelle, appuyer en même temps sur le bouton de blocage !</p>		

Libérer la charge



<p data-bbox="223 1556 422 1646">Bouton de blocage</p> 		<p data-bbox="1141 1478 1380 1512">Option télécommande</p> 
<p data-bbox="199 1848 805 1915">Pour déplacer la soupape coulissante manuelle, appuyer en même temps sur le bouton de blocage !</p>	<p data-bbox="837 1848 1396 1915">Pour libérer la charge, appuyer en même temps sur les deux boutons.</p>	

2.3 Plaque signalétique



La plaque signalétique sert à l'identification de l'engin. Les indications figurant sur la plaque signalétique doivent toujours être fournies lors de commandes de pièces détachées, de droits à la garantie et pour d'autres demandes concernant l'engin. La plaque signalétique est apposée sur la face externe de l'engin de levage et est solidement reliée à celui-ci.

Les données suivantes figurent sur la plaque signalétique :

- Type d'engin
- Numéro d'article
- Numéro de commande
- Numéro de série
- Année de construction
- Poids propre
- Charge admissible
- Tension

2.4 Générateur de vide

Pour générer du vide, on peut mettre en marche une ou deux pompes à vide à l'aide du commutateur marche / arrêt.

1 Pompe à vide : plus longue durée de vie de l'accu

2 Pompes à vide : temps d'aspiration plus court et débit d'air plus élevé

Si le vide baisse à $-0,53$ bar, les pompes à vide se mettent automatiquement en marche et ramènent le vide à $-0,66$ bar.

2.5 Platines d'aspiration

Les platines d'aspiration (non comprises dans la livraison) servent à aspirer la charge (voir également chapitre 5.3). Seuls les objets ayant une surface plane et compacte conviennent au levage avec cet appareil.

2.6 Dispositifs de sécurité

L'engin de levage dispose des dispositifs de sécurité suivants

- ⇒ Lampe éclair rouge (surveille le vide d'exploitation et les coupures d'énergie)
- ⇒ Commutateur de vide
- ⇒ Manomètre avec voyant rouge de zone de danger
- ⇒ 1 réservoir de vide
- ⇒ Chaîne de sécurité pour charge

Contrôler les dispositifs de sécurité (pour les intervalles de maintenance, voir chapitre 9.2).

3 Données techniques

	Standard SM-600	Power SM-600-POWER /-POWER-FFS
Force portance maximale *	600 kg	
Poids propre (sans ventouse)	ca. 34 kg	ca. 35 kg
Volume du réservoir de sécurité	ca. 2,5 l	
Volume aspiré de la pompe à vide		
Position de l'interrupteur 1 (1 pompe marche)	29 l/min	52 l/min
Position de l'interrupteur 2 (2 pompes marchent)	58 l/min	104 l/min
Pression finale	500 mbar vide	
Température domaine d'utilisation	+3 °C à 40 °C	
Voltage	12 V DC	
Consommation de courant		
Position de l'interrupteur 1 (1 pompe marche)	3,8 A	4,5 A
Position de l'interrupteur 2 (2 pompes marchent)	7,6 A	9,0 A
Liquide refoulé	air	



*) La capacité de charge maximale de l'engin de levage est dépendante de la platine d'aspiration (non comprise dans le volume de livraison, voir également chapitre 5.3)



DANGER

Risque d'accident par dépassement de la capacité de charge

La capacité de charge admissible du moyen de transport ou de levage (par exemple grue, palan à chaîne, véhicule de chantier, ...) et de l'engin de levage doit être au moins aussi grande que le poids propre et la capacité de charge de l'engin de levage pris ensemble !

3.1 Données techniques pour télécommande (seulement SM-600-POWER-FFS)

	Power SM-600-POWER-FFS
Bande de fréquence	2405-2480 MHz
Nombre de canaux	16 (canaux 11 à 26)
Code IP	67
Température de fonctionnement	-20 à +55 °C / -4 à +130 °F

4 Livraison, emballage et transport

4.1 Livraison

4.1.1 Volume de la livraison

Vous trouverez le volume exact de la livraison dans la confirmation de la commande. Les poids et les dimensions sont listés dans les papiers de livraison.



La notice d'emploi et de maintenance est partie intégrante de l'engin de levage et doit être jointe à chaque changement de site.

4.1.2 Contrôler que la livraison est complète

Contrôler l'ensemble de l'envoi au moyen des papiers de livraison joints pour s'assurer que celui-ci est complet !

4.1.3 Déclarer les dommages

Après la livraison de l'envoi, il est nécessaire de déclarer aussitôt à l'expéditeur et à la société Probst GmbH les dommages dus à un emballage défectueux ou également au transport.





4.2 Emballage

L'engin de levage est livré emballé sur une palette.



Le matériel d'emballage doit être éliminé conformément à la législation et aux directives spécifiques au pays. Les aides au transport et les dispositifs de sécurité ayant une marque distinctive doivent être enlevés.

4.3 Transport



 AVERTISSEMENT	
  	<p>Risque de blessure dû à un transport et à un déchargement non conformes</p> <p>Des dommages corporels et matériels en sont la conséquence.</p> <ul style="list-style-type: none"> ▶ Seul un personnel formé aux techniques de sécurité et au maniement des chariots de manutention est autorisé à décharger et à transporter ▶ Utilisez des engins de levage et des moyens d'accrochage aux dimensions suffisantes. ▶ Les marchandises transportées doivent être sécurisées conformément aux prescriptions spécifiques aux pays (directives BAG en Allemagne). ▶ Équipement de protection personnel

4.4 Retrait de l'engin de levage de la palette

L'emballage doit être ouvert avec soin !

En cas d'utilisation de couteaux ou de lames pour ouvrir l'emballage, veillez à n'endommager aucun élément.

Retirez maintenant l'engin de levage avec soin !

 ATTENTION	
 	<p>Éléments lourds sur la palette</p> <p>Lors de l'ouverture de l'emballage, des éléments peuvent avoir glissé et tomber. Ceci peut entraîner des contusions et des coupures.</p> <p>▶ Portez des chaussures de sécurité (S1), des gants de travail (catégorie de sécurité 2133) !</p>

ATTENTION	
	<p>Retrait non conforme du système hors de la caisse de transport</p> <p>Détérioration du système</p> <p>▶ Ne pas employer la force</p> <p>▶ Se conformer aux consignes pour retirer le système de la caisse de transport.</p>

5 Mise en service





Avant la première mise en service, les opérations décrites ci-dessous doivent être contrôlées par un spécialiste qualifié et le chapitre 1.11 (exigences et indications valant pour le personnel d'installation, de maintenance et de commande) doit être lu.

5.1 Liste d'outils





Aucun outil n'est nécessaire pour l'installation.

5.2 Accrocher l'engin de levage

 AVERTISSEMENT	
 	<p>Risque de rupture dû à un montage incorrect</p> <p>Des personnes sont blessées ou assommées par la chute d'éléments !</p> <ul style="list-style-type: none"> ▶ L'engin de levage ne doit être accroché qu'à l'œillet d'accrochage ! ▶ La capacité de charge admissible du moyen de transport ou de levage (par exemple grue, palan à chaîne, véhicule de chantier, ...) et de l'engin de levage doit être au moins aussi grande que le poids propre et la capacité de charge de l'engin de levage pris ensemble ! ▶ Le moyen de transport ou de levage utilisé et l'engin de levage doivent être en parfait état !

5.3 Montage de la platine d'aspiration sur l'engin de levage

La platine d'aspiration et le matériel de fixation ne sont pas compris dans le volume de livraison.

 DANGER	
	<p>Risque d'accident dû à une mise en route par inadvertance.</p> <ul style="list-style-type: none"> ▶ Mettre l'engin de levage hors circuit avant le montage de la platine d'aspiration !
 DANGER	
	<p>Risque d'accident dû à un matériel de fixation non approprié.</p> <ul style="list-style-type: none"> ▶ La platine d'aspiration doit être dimensionnée côté client en fonction de la charge (surface, densité, poids). Le client s'engage à apporter la preuve de la solidité statique et des forces de maintien en fonction du vide que l'on peut obtenir ainsi qu'à respecter les facteurs de sécurité. Il convient ici de prendre pour base la norme DIN EN 13155 dans la version en vigueur au moment du montage. ▶ La platine d'aspiration doit être montée avec un matériel de fixation approprié. <ul style="list-style-type: none"> • 2 tiges filetées M12 – 4.6, longueur 247 mm • 2 écrous à anneau DIN 582 E – M12 – C15 galvanisés

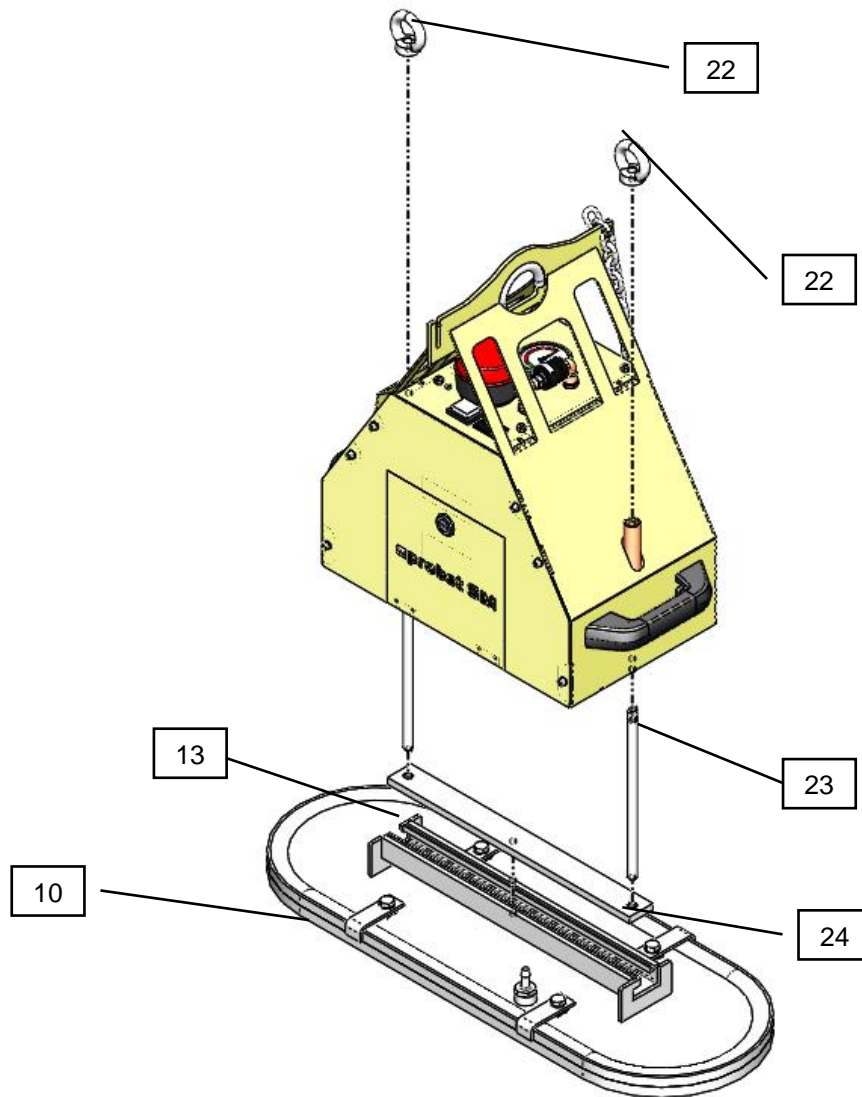

Matériel de fixation pour platine d'aspiration (non compris dans la livraison) :

Pos.	Description	Pos.	Description
10	Ventouse	23	Tige filetée
13	Rail C de la ventouse	24	Coulisseau
22	Écrou à anneau		

1. Visser les deux tiges filetées dans les coulisseaux de telle manière que le filetage soit entièrement vissé.
2. Introduire les deux tiges filetées par le bas dans les deux perçages de fixation du boîtier jusqu'à ce que les tiges filetées sortent en haut du boîtier.
3. Visser l'écrou à anneau de 2-3 pas de vis sur les tiges filetées sans le serrer.
4. Pousser sur le côté le rail en C de la platine d'aspiration sur le coulisseau.
5. Positionner la platine d'aspiration au centre.
6. Serrer les écrous à anneau et contrôler la bonne fixation de la platine d'aspiration.
7. Raccorder le flexible à vide de la platine d'aspiration.
8. Contrôler l'étanchéité (voir chapitre 9.5.3).
9. Contrôler tous les dispositifs de sécurité avant de travailler avec les charges.



L'installation de l'engin de levage est achevée dès que l'on a effectué avec succès au moins 3 ou 4 cycles d'essai avec une charge. Les essais exigibles en Europe avant la mise en service selon la norme DIN EN 13155 sont couverts par un examen de type.

5.4 Remplacement de la platine d'aspiration

1. Déposer l'engin de levage sur une surface plane, propre.
2. Mettre l'engin de levage hors circuit.
3. Retirer le flexible à vide.
4. Desserrer les écrous à anneau.
5. Soulever l'engin de levage en tenant fermement la platine d'aspiration.
6. Fixer une nouvelle platine d'aspiration sur l'engin de levage (voir chapitre 5.3).
7. Entreposer la platine d'aspiration non utilisée à un endroit approprié (voir chapitre 7).

5.5 Alimentation en énergie

L'engin de levage est alimenté par un accu intégré. Une alimentation externe en énergie n'est pas nécessaire pendant le fonctionnement.



Un chargement d'accu suffit environ pour une journée de travail.

Pour maintenir l'engin de levage constamment en état de marche, l'accu doit être rechargé après chaque utilisation.

L'accu peut être chargé en permanence.



On peut de plus disposer d'un accu de réserve (indications pour le remplacement de l'accu, voir chapitre 9.2).



6 Exploitation



Indication pour la location / le prêt :
lors de chaque location/prêt de l'engin de levage, la notice d'emploi originale correspondante doit impérativement être fournie avec l'engin (si la langue du pays utilisateur respectif diverge, il convient de fournir dans chaque cas la traduction de la notice d'emploi originale) !

6.1 Consignes de sécurité générales pour l'exploitation

 AVERTISSEMENT	
	<p>Non-respect des consignes de sécurité générales pour l'exploitation courante</p> <p>Des dommages touchant les personnes et le système en sont la conséquence.</p> <p>▶ Le système doit être utilisé exclusivement par un personnel formé qui a lu et compris la notice d'emploi et de maintenance.</p>

 AVERTISSEMENT	
	<p>Risque de blessure dû à une forte pression négative et à un fort débit volumétrique</p> <p>Les cheveux, la peau, les membres et les vêtements sont aspirés.</p> <p>▶ Porter des vêtements collants, utiliser un filet pour les cheveux.</p> <p>▶ Ne pas regarder dans le raccordement d'aspiration.</p> <p>▶ Ne pas introduire les doigts dans le raccordement d'aspiration.</p> <p>▶ Ne pas rapprocher des orifices corporels</p>



AVERTISSEMENT



Interdiction

Danger dû à la chute d'objets

- quand la pression négative s'arrête
- quand la charge se détache en raison d'une collision
- quand les éléments de construction sont défailants par suite d'une surcharge ou de modifications non autorisées

Des personnes sont touchées et blessées ou assommées !

- ▶ Personne ne doit se tenir dans la zone de danger de la charge.
- ▶ Ne jamais transporter une charge au-dessus des personnes.
- ▶ Il faut revêtir un équipement de sécurité adéquat avant le transport.
- ▶ Ne travailler que si l'on a une vue dégagée de l'ensemble de la zone de travail.
- ▶ Faire attention aux autres personnes se trouvant dans la zone de travail !
- ▶ Ne pas lâcher la poignée de maintien de l'engin de levage aussi longtemps qu'une charge est soulevée.
- ▶ Ne jamais tirer, tracter ou traîner de charges en position oblique.
- ▶ Ne jamais dégager de charges bloquées avec l'engin de levage.
- ▶ N'aspirer et ne soulever que des charges appropriées (contrôler par des essais la stabilité propre et la porosité).
- ▶ L'utilisateur / l'exploitant doit sécuriser la zone de travail. Les personnes ou les installations nécessaires à cet effet doivent être mises à disposition pendant le processus de levage / de transport.
- ▶ La capacité de charge admissible par platine d'aspiration ne doit pas être dépassée.
- ▶ Ne pas déposer d'éléments sur l'engin de levage.
- ▶ Le vide ne doit pas être interrompu pendant la manipulation.
- ▶ **Ne soulevez et ne transportez la charge que lorsque la chaîne de sécurité de la charge est en place !**
- ▶ **Ne travailler avec l'engin qu'à proximité du sol.**
En opération de levage : La charge aspirée doit être abaissée immédiatement après le levage (par ex. d'une palette ou d'un camion) jusqu'à juste au-dessus du sol (env. 20 - 30 cm). La charge est ensuite arrimée par la chaîne de sécurité et ne peut être transportée qu'ensuite sur le lieu de montage. Pour transporter la charge, ne la soulever qu'aussi haut que nécessaire (environ 0,5 m au-dessus du niveau du sol recommandé).
- ▶ **Il est interdit de faire passer l'engin au-dessus des personnes.**



6.2 Contrôles avant le début du travail

 AVERTISSEMENT	
	<p>Danger dû à la chute d'objets</p> <ul style="list-style-type: none"> ▶ 1. Contrôler l'état de charge de l'accu (affichage position 7, pour le remplacement de l'accu voir chapitre 9.2). <ul style="list-style-type: none"> • La batterie est pleine lorsque l'indicateur de niveau de charge est VERT dans les 10 premières secondes après la mise sous tension. • Après 10 secondes, l'indicateur de niveau de charge peut commuter sur JAUNE. • Le dispositif de levage peut être utilisé • Rechargez la batterie avant utilisation lorsque l'indicateur de niveau de charge est sur JAUNE ou ROUGE lorsque l'appareil est mis sous tension. • Une charge de batterie tient environ une journée de travail. • Afin de maintenir le dispositif de levage prêt à fonctionner à tout moment, la batterie doit être chargée après chaque phase de travail. • La batterie peut être chargée en permanence. 2. Contrôler l'état de la platine d'aspiration. 3. S'assurer que la platine d'aspiration est bien fixée. 4. Contrôler les dispositifs de sécurité (voir chapitre 2.6). 5. Contrôler le filtre à impuretés et le remplacer le cas échéant. 6. Contrôler l'eau de condensation et la vidanger le cas échéant (voir chapitre 9.7). 7. S'assurer que les moyens de transport et de levage utilisés (par exemple grue, palan à chaîne, véhicule de chantier, ...) ainsi que l'engin de levage sont appropriés (capacité de charge maximale, voir chapitre 3).

6.3 Comportement en cas d'urgence

Il y a urgence :

- en cas de panne de l'alimentation en vide (par exemple en cas de coupure d'énergie → la production de vide s'arrête). Un réservoir intégré maintient encore dans ce cas la pression négative pour un court laps de temps de sécurité (dépendant de la compacité de la surface de la charge).
- en cas de survenue d'une fuite (par exemple déchirure du flexible)
- par l'apparition de forces lors d'une collision
- lorsque, pendant la manipulation de la charge, le niveau de vide descend au-dessous de -0,6 bar dans la zone rouge du manomètre.

 AVERTISSEMENT	
	<p>Risque de blessure dû à la chute du niveau de vide lors d'une coupure d'énergie ou d'une panne de production de vide.</p> <p>Il y aura contusions et blessures de personnes.</p> <ul style="list-style-type: none"> ▶ L'opérateur doit en cas de danger donner immédiatement l'alarme. ▶ Ne jamais pénétrer dans la zone de danger. ▶ Si possible, déposer la charge pour la mettre en sécurité.

6.4 Option télécommande radio

La télécommande radio a été contrôlée et correspond aux valeurs limite pour un appareil numérique de la classe B conformément à la partie 15 des dispositions FCC. Ces valeurs limite doivent assurer une protection adaptée contre les interférences nocives dans les zones résidentielles.

La télécommande radio produit, utilise et émet des ondes haute fréquence pouvant provoquer des perturbations du trafic radio quand elle n'est pas utilisée en concordance avec les instructions.



On ne peut cependant garantir qu'aucune interférence ne se produise dans telle ou telle installation. Au cas où la télécommande radio déclenche des interférences affectant la réception des émissions radio ou de télévision, ce qui peut être établi en ouvrant ou en fermant la télécommande radio, il est recommandé d'éliminer l'interférence en recourant à une ou plusieurs des mesures suivantes :

- Réorienter ou repositionner l'antenne du récepteur.
- Augmenter la distance entre la télécommande radio et le récepteur.
- Consulter le revendeur ou un spécialiste radio/TV expérimenté.

 ATTENTION	
	<p>Risque de blessure par un mouvement incontrôlé de l'engin de levage</p> <ul style="list-style-type: none"> ▶ Ne pas quitter des yeux le parcours et la charge ! Ne travailler que lorsque la totalité de la zone de travail est clairement visible. ▶ Avant de libérer la charge, s'assurer que personne ne se trouve dans la zone de danger.

6.5 Soulever la charge, aspirer

 AVERTISSEMENT	
	<p>Risque de blessure dû à la chute de la charge</p> <ul style="list-style-type: none"> ▶ Avant chaque opération de transport, sécuriser la charge à l'aide de la chaîne de sécurité pour charge. ▶ Soulever la charge seulement à partir d'une valeur de vide de -0,6 bar (aiguille du manomètre dans la zone verte). La capacité de charge est sinon insuffisante. ▶ Ne jamais soulever ou abaisser la charge par à-coups. ▶ Des charges ayant des surfaces humides, mouillées, huileuses, gelées, salies, poussiéreuses ou réduisant d'autre manière le frottement, doivent être nettoyées avant l'aspiration ! ▶ La capacité de charge maximale de la platine d'aspiration ne doit pas être dépassée.

 AVERTISSEMENT	
	<p>Risque de blessure par un mouvement incontrôlé de l'engin de levage</p> <ul style="list-style-type: none"> ▶ Saisir la charge toujours au centre de gravité ▶ Rien ne doit retenir la charge. ▶ La charge ne doit adhérer nulle part. ▶ La charge ne doit pas être coincée.

Aspirer la charge

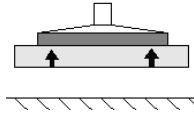

Stonemagnet Standard

SM-600

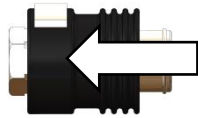

Pour déplacer la soupape coulissante manuelle, appuyer en même temps sur le bouton de blocage !

Stonemagnet Power

SM-600-POWER

SM-600-POWER-FFS



Option télécommande radio



1. Positionner l'engin de levage au centre de gravité de la charge.
2. S'assurer que la totalité de la surface de la platine d'aspiration repose sur la charge.
3. Sécuriser la charge au moyen de la chaîne de sécurité pour charge.
 - Soulever très légèrement (20-30 cm environ) l'appareil avec la charge aspirée.
 - Retirer la chaîne de sécurité du bacs de rangement et faire passer sous la charge soulevée et faire passer sous la charge soulevée.
 - **Il ne faut jamais mettre les mains sous la charge (dalle en pierre) ! Risque d'écrasement!!!**
 - Tendre et accrocher la chaîne de sécurité sur l'autre côté de l'appareil (ranger l'extrémité de la chaîne dans les bacs de rangement).
 - Les chaînes de sécurité doivent **être tendues** contre la charge (voir figure ci-dessous), afin que la charge soit maintenue par la chaîne de sécurité en cas de défaillance du système de production du vide (par ex. en cas de panne de courant).
 - La chaîne de sécurité **ne doit jamais pendre librement sous la charge**, la charge risque de tomber en cas de défaillance du système de production du vide (par ex. en cas de panne de courant). Danger d'accident! Éviter de tirer de biais.
4. Mettre en marche l'alimentation en énergie.
→ Lampe éclair en fonction, jusqu'à ce que la pression négative atteigne -0,6 bar.
5. Actionner l'élément de commande (voir figure du haut selon le modèle).
6. Observer le manomètre. Dès que la pression négative atteint -0,6 bar (aiguille du manomètre dans la zone verte), soulever la charge.

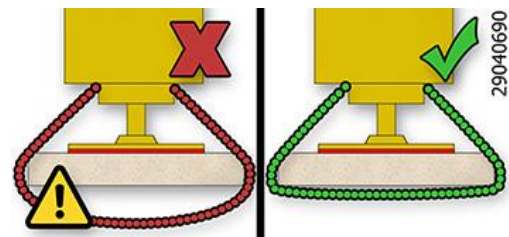

6.6 Guider la charge

 AVERTISSEMENT	
	<p>Risque de blessure par un mouvement incontrôlé de l'engin de levage</p> <ul style="list-style-type: none"> ▶ Utiliser la poignée de maintien pour guider la charge. Respecter les distances de sécurité. ▶ Ne pas quitter des yeux le parcours et la charge ! Ne pas marcher devant la charge ! Risque de trébuchement ! Lorsque l'on stoppe le mouvement de déplacement horizontal, la charge oscille dans la direction du déplacement. ▶ Transporter les charges toujours aussi près du sol que possible et adapter la vitesse du transport à la situation donnée. ▶ Une conduite saccadée de l'engin de levage est interdite car celui-ci peut commencer à pivoter et à osciller.

AVERTISSEMENT	
	<p>Risque de blessure dû à la chute de la charge</p> <ul style="list-style-type: none"> ▶ Ne jamais conduire rapidement sur un terrain accidenté l'engin de levage ayant aspiré une charge.

6.7 Déposer la charge, la détacher

AVERTISSEMENT	
 	<p>Risque de blessure par des éléments qui basculent</p> <ul style="list-style-type: none"> ▶ Faire descendre la charge avec précaution (jusqu'à une distance de 20-30 cm du sol), décrocher les chaînes de sécurité et tirer pour la faire repasser sous la charge. Il ne faut jamais mettre les mains sous la charge (dalle en pierre) ! Risque d'écrasement!!! Remettre les chaînes de sécurité dans les bacs de rangement. <p>La charge doit reposer de façon stable sur le sol ou dans un dispositif de dépose approprié avant d'être détachée de l'engin de levage.</p> <ul style="list-style-type: none"> ▶ Le cas échéant, la charge doit être sécurisée contre un glissement ou un basculement avant d'être détachée de l'engin de levage. ▶ Une fois la charge absorbée par la chaîne de sécurité, celle-ci doit être contrôlée correctement et, si nécessaire, remplacée. <p>Les chaînes de sécurité endommagées ne doivent plus être utilisées !</p>

Libérer la charge

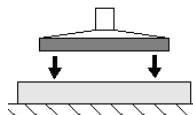

Stonemagnet Standard SM-600	Stonemagnet Power SM-600-POWER SM-600-POWER-FFS
<div style="border: 1px solid black; padding: 2px; display: inline-block; margin-bottom: 10px;">Bouton de blocage</div>	<div style="display: flex; justify-content: space-around; align-items: center;"> <div style="text-align: center;"> </div> <div style="text-align: center;"> <p>Option télécommande radio</p> </div> </div>
Pour déplacer la soupape coulissante manuelle, appuyer en même temps sur le bouton de blocage !	Pour libérer la charge, appuyer en même temps sur les deux boutons.

1. Abaisser la charge et la déposer de manière stable sur une surface plane et dégagée.
2. S'assurer que la charge ne peut pas glisser ou basculer. Pour la déposer, actionner l'élément de commande (voir figure du haut selon le modèle).

La charge se détache. L'engin de levage peut à nouveau être soulevé.

6.8 Garer l'engin de levage

Le parage de courte durée de l'engin de levage mis à l'arrêt est qualifié de « stationnement ».

Procédure :

1. Couper l'alimentation en énergie.
2. Le cas échéant, évacuer l'eau de condensation (voir chapitre 9.7).
3. Laisser l'engin de levage suspendu dans une position stable au moyen de transport ou de levage (ne pas le déposer sur la charge !).

7 Entreposage

Possibilités d'un entreposage correct en cas de non utilisation :

- Laisser l'engin de levage suspendu ou
- le stocker posé au sol,
IMPORTANT ! Avant l'entreposage, démonter la platine d'aspiration et la stocker à part.

ATTENTION	
	<p>Détérioration de la pince aspirante</p> <p>Les ventouses sont déformées, vieillissent prématurément et sont sujettes à défaillance.</p> <p>▶ Stockage des ventouses et des pinces aspirantes selon la recommandation de stockage pour éléments en élastomère.</p>

Recommandation de stockage pour éléments en élastomère

Les effets de l'ozone, de la lumière (en particulier rayons UV), de la chaleur, de l'oxygène, de l'humidité et les effets mécaniques peuvent raccourcir la durée de vie des produits en caoutchouc. Stockez pour cette raison les éléments en caoutchouc dans un endroit frais (de 0 °C à + 15 °C, mais au maximum à 25 °C), sombre, sec, peu poussiéreux, protégé des intempéries, de l'ozone et des courants d'air ainsi qu'exempt de contraintes (par exemple empilement approprié sans déformation).

S'assurer qu'aucune eau de condensation ne se trouve dans le réservoir (verre de regard position 18). Le cas échéant, évacuer l'eau de condensation (voir chapitre 9.7).

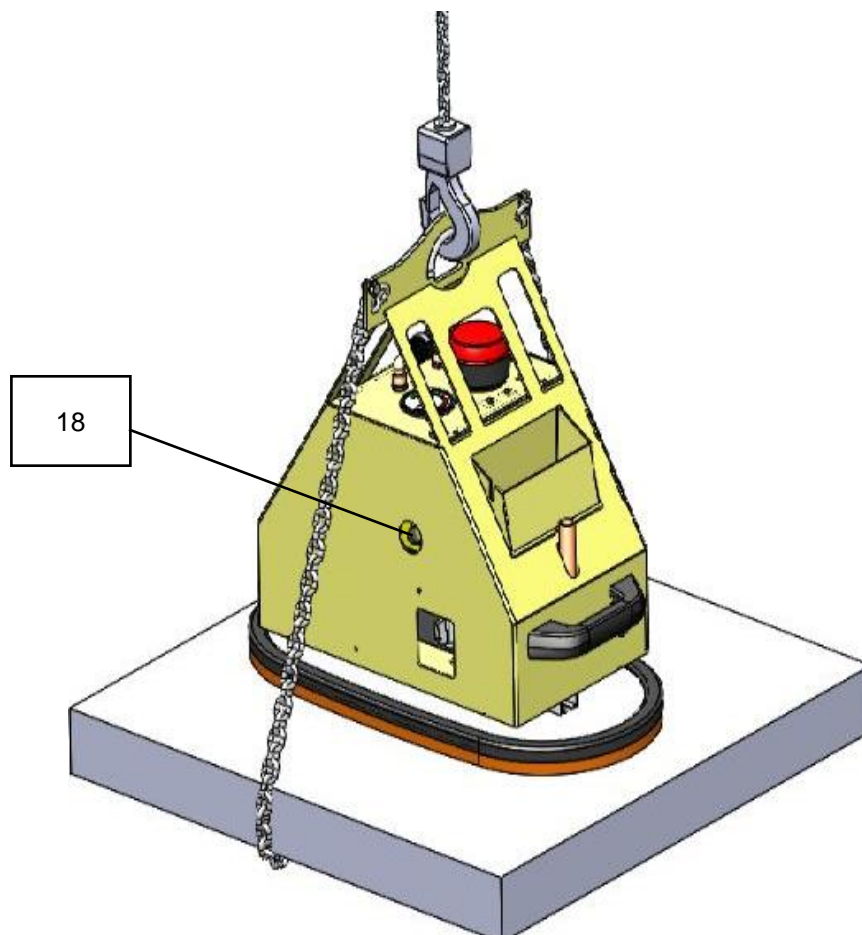

8 Dépannage

L'engin de levage ne doit être installé, entretenu et réparé que par des spécialistes et mécaniciens qualifiés.
Voir chapitre 1.10 Obligations de l'exploitant



Après des travaux de réparation ou de maintenance, contrôler en tout cas les dispositifs de sécurité comme décrits au chapitre "9.5 Renouveler l'étanchéité du raccord de la platine d'aspiration lors du vissage !



Si la **charge ne peut être soulevée**, parcourez la liste suivante pour trouver la panne et y remédier.



Panne	Cause	Remède
La production de vide ne fonctionne pas	Accu vide ou défectueux	Recharger ou remplacer accu (voir chapitre 9.2)
	Connecteur non relié à l'accu	Raccorder le connecteur
La production de vide fonctionne. La pression négative de -0,6 bar n'est pas atteinte	La lèvre d'étanchéité de la platine d'aspiration est détériorée	Remplacer la platine d'aspiration
	La charge présente des fissures, des évidements ou est poreuse	La manipulation de la charge avec cet engin de levage n'est pas possible
	Le manomètre est défectueux	Remplacer le manomètre
	Le flexible / les vissages ne sont pas étanches	Remplacer les éléments de construction / réaliser l'étanchéité
	Le commutateur de vide est mal réglé / défectueux	Téléphoner au SAV
	Le filtre est encrassé	Nettoyer le filtre à l'air comprimé ou le remplacer
	Le filtre n'est pas fermé	Fermer le filtre
	Le flexible / les vissages ne sont pas étanches	Remplacer les éléments de construction / réaliser l'étanchéité
	Commutateur marche / arrêt sur position « I » (une seule pompe à vide fonctionne)	Mettre le commutateur marche / arrêt sur position « II » (deux pompes à vide fonctionnent)
La production de vide fonctionne, mais n'aspire pas	La soupape coulissante manuelle est en position « Libération »	Pousser la soupape coulissante manuelle en position « aspirer la charge »
	La soupape coulissante manuelle est défectueuse	Téléphoner au SAV
La lampe éclair clignote, la pression négative tombe à -0,48 bar	La charge présente des fissures, des évidements ou est poreuse	La manipulation de la charge avec cet engin de levage n'est pas possible
	La lèvre d'étanchéité est détériorée	Remplacer la platine d'aspiration
	Le flexible est défectueux / les vissages ne sont pas étanches	Remplacer les éléments
	Le commutateur de vide est mal réglé / défectueux	Téléphoner au SAV

9 Maintenance

9.1 Remarques générales

L'engin de levage ne doit être installé, entretenu et réparé que par des spécialistes et mécaniciens qualifiés. Voir chapitre 1.10 Obligations de l'exploitant.

 AVERTISSEMENT	
	<p>Risque d'accident en cas de maintenance du système par un personnel non formé</p> <p>Des dommages corporels graves en résultent.</p> <p>▶ Assurer la maintenance du système exclusivement par un personnel formé qui a lu et compris la notice d'emploi et de maintenance.</p>

 AVERTISSEMENT	
	<p>Risque d'accident dû à des éléments usés et non entretenus</p> <p>Des éléments usés et non entretenus peuvent provoquer des dommages ayant pour conséquence la défaillance de l'engin de levage et même de très graves accidents.</p> <p>▶ Respecter les conditions de fonctionnement, de maintenance et d'entretien prescrites dans la présente notice d'emploi et de maintenance.</p>

9.2 Remplacer l'accu

Si la durabilité de l'accu diminue, il doit être remplacé.

Procédure :

1. Mettre l'engin hors circuit.
2. Ouvrir le couvercle de l'appareil (à l'aide d'un grand tournevis pour vis à fente).
3. Retirer le connecteur.
4. Extraire l'accu.
5. Fixer les câbles de pôles sur le nouvel accu.
Veillez ce faisant à respecter la bonne polarité :
ROUGE = PÔLE POSITIF
NOIR = PÔLE NEGATIF
6. Mettre l'accu en place.
7. Raccorder le connecteur.
8. Fermer le couvercle de l'engin et le verrouiller à l'aide du tournevis.
9. Éliminer l'accu usagé selon les règles.



9.3 Générateur de vide

Voir le mode d'emploi de la pompe à vide ci-joint / (annexe).

9.4 Platines d'aspiration / lèvres d'étanchéité

- Nettoyer au moins une fois par semaine les lèvres d'étanchéité en ôtant les objets qui y adhèrent et les salissures telles que sable, particules de pierre et poussière.
- Nettoyer le caoutchouc spongieux à l'air comprimé et/ou au jet d'eau ou bien à l'eau savonneuse.
- Remplacer immédiatement les platines d'aspiration détériorées ou usées (fissures, trous, ondulation).
- Remplacer toujours complètement les platines d'aspiration !



Conseil :

Le vissage de la platine d'aspiration est plus facile à desserrer si on le réchauffe !

Renouveler l'étanchéité du raccord de la platine d'aspiration lors du vissage !

9.5 Contrôler les dispositifs de sécurité

Contrôlez les dispositifs de sécurité (voir chapitre 2.6) au début de chaque journée de travail (en cas de service discontinu) ou une fois par semaine (en cas de service permanent).

9.5.1 Contrôler la lampe éclair

Mettre en marche la production de vide.

Poser l'engin de levage sur une charge ayant une surface lisse et compacte et aspirer la charge.



AVERTISSEMENT

Risque de blessure par chute de la charge lorsque la pression négative s'effondre

La charge peut se détacher et tomber lors de la vérification.

- ▶ Aspirer seulement la charge, ne pas la soulever.

Lorsque la pression négative est établie, soulever légèrement la lèvre d'étanchéité de la platine d'aspiration pour simuler un défaut d'étanchéité.

La pression négative diminue sur le manomètre. Lorsque la pression négative descend au-dessous de -0,43 bar, la lampe éclair s'allume.



AVERTISSEMENT

Risque de blessure dû à la chute de la charge

- ▶ Le commutateur de vide est réglé à l'usine et ne doit jamais être déréglé.

9.5.2 Contrôler les flexibles d'aspiration et les brides de fixation

Contrôlez la bonne fixation de tous les flexibles d'aspiration ainsi que de leurs brides, et le cas échéant les resserrer.

9.5.3 Contrôler l'étanchéité

Effectuer un contrôle mensuel de l'étanchéité.

1. Poser les platines d'aspiration sur une surface lisse et étanche (par exemple une plaque de tôle).
2. Mettre le vide en marche.
3. Aspirer la charge, mais ne pas la soulever (voir chapitre 6.5).

	AVERTISSEMENT
	<p style="text-align: center;">Risque de blessure par chute de la charge lorsque la pression négative s'effondre</p> <p style="text-align: center;">La charge peut se détacher et tomber lors de la vérification.</p> <p>▶ Aspirer seulement la charge, ne pas la soulever.</p>

1. Attendre jusqu'à ce qu'une pression négative d'environ -0,6 bar soit atteinte.
2. Mettre la pompe à vide hors circuit. La pression négative ne doit diminuer que de 0,1 bar au maximum en l'espace de 5 minutes.
3. Après le contrôle, détacher la charge (voir chapitre 6.7).

Éliminez les dysfonctionnements avant de mettre l'engin en service. Si des dysfonctionnements apparaissent pendant le service, mettre l'engin hors circuit et remédier aux dysfonctionnements.

9.6 Filtre

Contrôler au moins une fois par semaine le filtre à impuretés. En cas d'encrassement important, remplacer le filtre.

Procédure :

1. Ouvrir le couvercle de l'engin. Desserrer la bride de flexible et retirer le filtre.
2. Insérer un nouveau filtre et fixer celui-ci avec la bride de flexible.
3. Refermer le couvercle de l'engin.
4. Contrôler l'étanchéité (voir ci-dessus).

9.7 Évacuer l'eau de condensation

Lors de la production de vide, il y a formation d'eau de condensation en raison de l'humidité de l'air. L'eau de condensation doit être évacuée au moins une fois par jour. Le cas échéant, contrôler le verre de regard (18).

Procédure :

1. Ouvrir la soupape de décharge (position 17) et évacuer l'eau
2. Fermer la soupape de décharge.

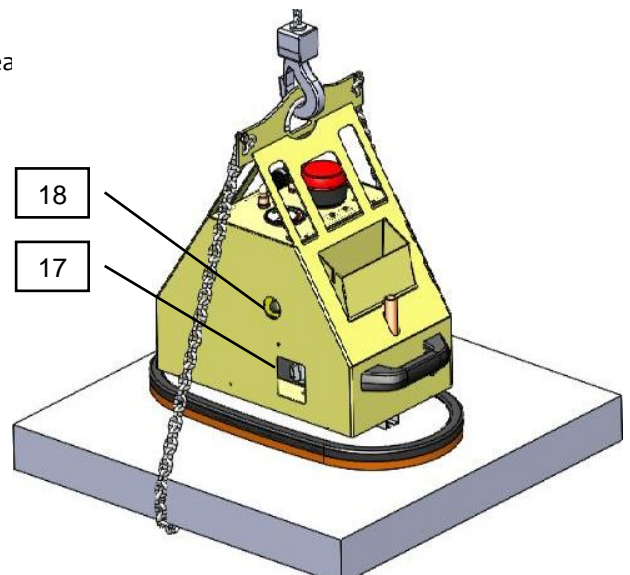
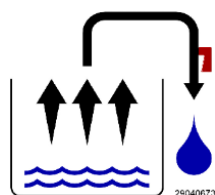

9.8 Plan de maintenance

9.8.1 Mécanique



Les intervalles de temps mentionnés ci-dessous doivent être raccourcis en cas de conditions d'utilisation dures.

Intervalle de temps	Travaux à effectuer
Première inspection après 25 heures de fonctionnement	Contrôler toutes les vis de fixation et les resserrer le cas échéant (ne doit être effectué que par un spécialiste).
Toutes les 50 heures de fonctionnement	Resserrer l'ensemble des vis de fixation (s'assurer que les vis sont resserrées conformément aux couples de serrage admissibles des classes de résistance correspondantes). Contrôler le parfait fonctionnement de toutes les articulations, commandes, boulons et roues dentées (s'il en existe), en cas de nécessité les mettre au point ou les remplacer.

9.8.2 Autres éléments de construction



Le contrôle annuel doit être effectué par un spécialiste (voir chapitre 0).

	Intervalle de temps				
	Tous les jours	Chaque semaine	Chaque mois	Tous les 6 mois	Vérification annuelle
Vérifier les dispositifs de sécurité: - Manomètre OK? Le dispositif d'avertissement s'enclenche en cas de pression négative / de surpression correcte ?	X				X
Vérifier le filtre, le remplacer si nécessaire		X			X
Contrôler l'état de charge de l'accu (affichage position 7)	X				X
Remplacer l'accu si nécessaire					X
Les flexibles de vide sont-ils en bon état (pas usés, pas pliés, sans zones de frottement et de ce fait étanches)?			X		X
Toutes les fixations sont-elles solides (brides de flexible, etc.) ?				X	X
Les plaques signalétiques, les panneaux signalant la capacité de charge et les panneaux d'avertissement sont-ils complets et lisibles ?					X
La notice d'emploi et de maintenance existe-elle encore et est-elle connue des utilisateurs ?					X

Contrôle des éléments porteurs (par exemple suspension, boulons, attaches ...). Recherche de fissures, déformations, usure, corrosion, défaillance de fonctionnement et d'autres détériorations.					X
Nettoyer les platines d'aspiration / effectuer un contrôle, pas de fissures, La lèvre d'étanchéité est-elle homogène, etc. ? Le cas échéant, remplacer		X			X
La plaquette de contrôle est-elle renouvelée ?					X
État général de l'engin					X
Contrôle d'étanchéité			X		X
Évacuer l'eau de condensation	X				X
Vérifier l'état de la chaîne de sécurité de la charge 1)					X

- 1) Une fois la charge absorbée par la chaîne de sécurité, celle-ci doit être contrôlée correctement et, si nécessaire, remplacée. Les chaînes de sécurité endommagées ne doivent plus être utilisées !

Contrôle annuel L'entrepreneur doit veiller à ce que l'appareil soit contrôlée au moins une fois par an par un expert, et à ce que les déficiences constatées soient réparées immédiatement (→ BGR 500).

Observer les prescriptions correspondantes des associations professionnelles déclaration de conformité.

Lorsqu'un contrôle a été effectué et que les déficiences ont été réparées sur l'appareil, nous conseillons d'apposer la plaquette « CONTRÔLE DE SÉCURITÉ » bien lisiblement sur l'appareil. Ces plaquettes peuvent être obtenues auprès de notre société. (N° de commande : 2904.0056+vignette du contrôle technique avec date).



La vérification par un expert doit être impérativement documentée.

Appareil	Année	Date	Expert	Société

9.9 Nettoyage

Utilisez pour nettoyer l'engin de levage exclusivement un nettoyant à froid. (Ne pas utiliser d'éther de pétrole ou de liquides décapants : les flexibles pourraient perdre leur étanchéité ou être détruits). Le nettoyage des platines d'aspiration peut être effectué avec du savon et de l'eau chaude. Ne pas utiliser de nettoyant à froid pour les lèvres d'étanchéité de la ventouse !

9.10 Pièces détachées

Nous garantissons uniquement les pièces détachées d'origine livrées par nos soins. Pour des dommages dus à l'utilisation de pièces détachées et d'accessoires qui ne sont pas d'origine, la société Probst GmbH exclut toute responsabilité et toute garantie.

Veillez pour toute commande de pièces détachées indiquer le numéro de commande, le numéro de série de l'engin de levage ainsi que la référence de la pièce (voir plaque signalétique et liste de pièces de rechange).

10 Mise hors service et élimination

L'engin de levage ne doit être mis hors service et préparé pour l'élimination que par des professionnels qualifiés.

Procédure :

1. Désolidariser l'engin de levage du moyen de transport ou de levage.
2. Démontez l'accu et l'éliminez selon les règles (voir chapitre 9.2).
3. Démontez la platine d'aspiration et l'éliminez.
4. Détachez les brides de fixation des flexibles, retirez les flexibles.
5. Démontez le corps de base et l'éliminez.

Pour une élimination conforme, veuillez vous adresser à une entreprise d'élimination des matériels techniques en lui demandant de respecter les règlements pour la mise au rebut et la protection de l'environnement actuellement en vigueur.

Le fabricant de l'engin se fera un plaisir de vous aider dans la recherche d'une entreprise adéquate.

Preuve de maintenance



La garantie ne peut s'appliquer pour cet appareil qu'à condition que les travaux de maintenance prévus aient été effectués (par un atelier spécialisé et autorisé) ! Après la réalisation de travaux de maintenance périodiques, il faudra nous transmettre sans délai la présente attestation de maintenance (signée et revêtue de votre cachet). ¹⁾

¹⁾ par email à: service@probst-handling.de / par fax ou par courrier.

Opérateur: _____
 Modèle: _____ N° de commande.: _____
 N° de appareil: _____ Année de construction: _____

Première inspection après 25 heures de service		
Date:	Opérations à effectuer:	Maintenance de firme:
		<i>Pistil</i>
	
		Nom / Nom

Toutes les 50 heures de service		
Date:	Opérations à effectuer:	Maintenance de firme:
		<i>Pistil</i>
	
		Nom / Nom
		Maintenance de firme:
		<i>Pistil</i>
	
		Nom / Nom
		Maintenance de firme:
		<i>Pistil</i>
	
		Nom / Nom

Au minimum 1 fois par an		
Date:	Opérations à effectuer:	Maintenance de firme:
		<i>Pistil</i>
	
		Nom / Nom
		Maintenance de firme:
		<i>Pistil</i>
	
		Nom / Nom

SM-600-GREENLINE / SM-600-GREENLINE-Power SM-600-GREENLINE-POWER-FFS



IT | Istruzioni d'uso

Indice

1	Avvertenze di sicurezza.....	4
1.1	Classificazione delle avvertenze di sicurezza	4
1.2	Indicazioni di avvertimento	5
1.3	Segnali di obbligo.....	5
1.4	Segni di sicurezza	6
1.5	Scopo del presente manuale	7
1.6	Avvertenze generali di sicurezza.....	7
1.7	Sicurezza durante l'esercizio	9
1.7.1	Generale	9
1.8	Pericoli speciali	10
1.9	Utilizzo conforme	10
1.10	Obblighi dell'operatore	12
1.11	Requisiti per il luogo di installazione/di lavoro	13
1.11.1	Requisiti per il luogo di installazione	13
1.11.2	Requisiti per il luogo di lavoro.....	14
1.12	Definizione della zona di pericolo	14
1.13	Emissioni	16
1.14	Dispositivi di protezione individuale.....	17
1.14.1	Installazione/messa fuori servizio e smaltimento del dispositivo di sollevamento.....	17
1.14.2	Azionamento del dispositivo di sollevamento	17
1.14.3	Eliminazione dei guasti/Manutenzione del dispositivo di sollevamento	17
2	Descrizione del prodotto.....	18
2.1	Componenti.....	18
2.2	Elementi di comando.....	20
2.3	Targhetta segnaletica.....	21
2.4	Generatore di vuoto	21
2.5	Piastra di aspirazione	21
2.6	Dispositivi di sicurezza.....	21
3	Dati tecnici	22
3.1	Dati tecnici di telecomando (solo SM-600-POWER-FFS).....	22
4	Consegna, imballaggio e trasporto	23
4.1	Consegna.....	23
4.1.1	Fornitura.....	23
4.1.2	Verifica dell'integrità	23
4.1.3	Notifica di danni	23
4.2	Imballaggio.....	23
4.3	Trasporto.....	23
4.4	Scarico del dispositivo di sollevamento dal bancale	24
5	Messa in servizio.....	25
5.1	Elenco degli attrezzi	25
5.2	Fissaggio del dispositivo di sollevamento	25
5.3	Montaggio della piastra di aspirazione sul dispositivo di sollevamento	25
5.4	Sostituzione della piastra di aspirazione.....	27

5.5	Approvvigionamento energetico	27
6	Funzionamento	28
6.1	Avvertenze generali di sicurezza relative al funzionamento	28
6.2	Prove da effettuare prima di iniziare il lavoro	30
6.3	Comportamento in caso d'emergenza	30
6.4	Opzione radiocomando a distanza	31
6.5	Sollevamento e aspirazione del carico	31
6.6	Conduzione del carico	33
6.7	Deposito e rilascio del carico	34
6.8	Stazionamento del dispositivo di sollevamento.....	35
7	Stoccaggio	36
8	Eliminazione dei guasti.....	37
9	Manutenzione	38
9.1	Avvertenze generali	38
9.2	Sostituzione della batteria	38
9.3	Generatore di vuoto	38
9.4	Piastre di aspirazione / guarnizioni	38
9.5	Controllo dei dispositivi di sicurezza	39
9.5.1	Controllare la spia lampeggiante	39
9.5.2	Controllo dei tubi flessibili e dei morsetti di aspirazione.....	39
9.5.3	Prova della tenuta	39
9.6	Filtro.....	40
9.7	Drenaggio dell'acqua di condensa	40
9.8	Piano di manutenzione.....	41
9.8.1	Impianto meccanico.....	41
9.8.2	Restanti elementi costruttivi	41
9.9	Ispezione annua	42
9.10	Pulizia	43
9.11	Pezzi di ricambio	43
10	Messa fuori servizio e smaltimento	43

Dichiarazione di conformità CE

Designazione: Magnete di pietra SM
Tipo: SM-600-GREENLINE / SM-600-GREENLINE-Power SM-600-
GREENLINE-POWER-FFS
Articolo n: 52720006 / 52720007 / 52720008



Produttore: Probst GmbH
Gottlieb-Daimler-Strasse 6
71729 Erdmannhausen, Germania
info@probst-handling.de
www.probst-handling.com

La macchina sopra descritta è conforme ai requisiti pertinenti delle seguenti direttive UE:

2006/42/CE (Direttiva Macchine)

2014/30/UE (compatibilità elettromagnetica)

Sono stati utilizzati i seguenti standard e specifiche tecniche:

DIN EN ISO 12100

Sicurezza delle macchine - Principi generali di progettazione - Valutazione e minimizzazione dei rischi

2014/30/UE (compatibilità elettromagnetica)

DIN EN ISO 13857

Sicurezza del macchinario - Distanze di sicurezza per evitare che le zone pericolose siano raggiunte dagli arti superiori e inferiori (ISO 13857:2008).

DIN EN 1012-1 / DIN EN 1012-2

Compressori e pompe per vuoto; requisiti di sicurezza parte 1 e 2.

DIN EN 60204-1 (IEC 60204-1)

Sicurezza del macchinario, Equipaggiamento elettrico delle macchine industriali. Parte 1: Requisiti generali

Rappresentante autorizzato per la documentazione:

Nome: Jean Holderied

Indirizzo: Probst GmbH; Gottlieb-Daimler-Straße 6; 71729 Erdmannhausen, Germania

Firma, dati del firmatario:

Erdmannhausen, 05.03.2024.....

(Eric Wilhelm, direttore generale)

1 Avvertenze di sicurezza

1.1 Classificazione delle avvertenze di sicurezza

Pericolo

Questo cartello avverte di un pericolo che, se non viene evitato, può comportare lesioni gravi o addirittura la morte.

 PERICOLO	
	Tipo e fonte del pericolo Effetto del pericolo ▶ Misura correttiva del pericolo

Avvertenza

Questo cartello avverte di un pericolo che, se non viene evitato, può comportare lesioni gravi o addirittura la morte.

 AVVERTENZA	
	Tipo e fonte del pericolo Effetto del pericolo ▶ Misura correttiva del pericolo

Precauzione

Questo cartello avverte di un pericolo che, se non viene evitato, può comportare lesioni.

 ATTENZIONE	
	Tipo e fonte del pericolo Effetto del pericolo ▶ Misura correttiva del pericolo











Attenzione

Questo cartello avverte di un pericolo che, se non viene evitato, può comportare danni materiali.

ATTENZIONE	
	Tipo e fonte del pericolo Effetto del pericolo ▶ Misura correttiva del pericolo

1.2 Indicazioni di avvertimento

Spiegazione dei cartelli di avvertimento utilizzati nel manuale operativo e di manutenzione.

Segnale di avvertimento	Descrizione	Segnale di avvertimento	Descrizione
	Segnale di avvertimento generico		Pericolo: atmosfera potenzialmente esplosiva
	Pericolo: possibili lesioni alle mani		Pericolo: parti volanti
	Pericolo: carico sospeso		Pericolo: schiacciamento
	Pericolo: depressione		Pericolo: caduta
	Pericolo: caduta di parti della macchina		Pericolo: possibili danni all'udito



1.3 Segnali di obbligo

Spiegazione dei segnali di obbligo utilizzati nel manuale operativo e di manutenzione.



Segnali di obbligo	Descrizione	Segnali di obbligo	Descrizione
	Utilizzare una protezione per l'udito		Indossare calzature di sicurezza
	Indossare protezioni per le mani		Estrarre la spina dalla corrente
	Osservare il manuale operativo		Indossare una protezione per gli occhi

1.4 Segni di sicurezza

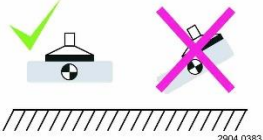
SEGNI DI DIVIETO

Simbolo	Significato	Articolo-N.:	Misura:
	Non è consentita la sosta sotto ai carichi sospesi. Pericolo di vita!	2904.0209	50 mm
	Il carico aspirato non deve mai essere sollevato e trasportato SENZA ulteriore fissaggio tramite la catena di fissaggio del carico.	2904.0767	55 x 25 mm
	Non sollevare gli elementi al di fuori del loro baricentro (sempre nel centro di gravità).	2904.0383	

SEGNI DI AVVERTIMENTO

Simbolo	Significato	Articolo-N.:	Misura:
	Pericolo che le mani restino schiacciate	2904.0220	50 mm
 (optional)	Riferimento al dispositivo radiocomandato.	2904.0647	130 x 50 mm

SEGNI OBBLIGATORI

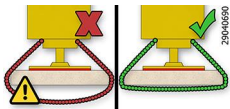
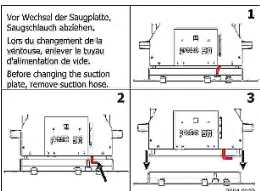
Simbolo	Significato	Articolo-N.:	Misura:
	Ogni persona coinvolta nelle operazioni di installazione, avviamento, utilizzo, manutenzione e riparazione del dispositivo deve aver letto e compreso le istruzioni d'uso e, in particolare, il capitolo "Sicurezza" qui contenuto.	2904.0665 2904.0666	30 mm 50 mm
	Le catene di sicurezza devono essere ben strette contro il carico. Le catene di sicurezza non devono mai essere lasciate libere sotto il carico!	2904.0690	25 x 55 mm
	Rimuovere il tubo flessibile di aspirazione prima di sostituire la piastra di aspirazione.	2904.0322	65 x 88 mm

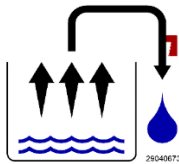

Scaricare ogni giorno l'acqua di condensa dall'unità.

2904.0673

40 x 40 mm

NOTE AGLI AZIONISTI

Simbolo	Significato	Articolo-N.:	Misura:
<p>(optional)</p>	Aspirazione e rilascio del carico	2904.0320	25 x 60 mm

1.5 Scopo del presente manuale

! AVVERTENZA	
	<p>Pericolo di incidenti in caso di mancata osservanza delle istruzioni</p> <ul style="list-style-type: none"> ▶ Il presente manuale operativo e di manutenzione forma parte integrante dei dispositivi di sollevamento Steinmagnet "Standard" e "Power" e contiene informazioni importanti per l'utilizzo degli stessi. ▶ Il manuale operativo e di manutenzione è stato adeguato alla fornitura della ditta Probst. Sono escluse e generalmente vietate eventuali modifiche al sistema effettuate dal cliente. ▶ Utilizzo, collegamento e messa in servizio potranno solo avvenire dopo aver letto e compreso il presente manuale operativo e di manutenzione!

1.6 Avvertenze generali di sicurezza

	<p>Il dispositivo di sollevamento della serie STONEMAGNET, di seguito denominato "dispositivo di sollevamento", garantisce sicurezza di funzionamento ed è stato costruito secondo le ultime tecnologie, a condizione che si osservi quanto disposto nel presente manuale. Qualora si maneggiasse scorrettamente il dispositivo di sollevamento, possono scaturire dei pericoli.</p>
--	---------------------------------------------------------------------------------------------------------------------------------------------------------------------------------------------------------------------------------------------------------------------------------------------------------------------------------------------------------------------------------------------

! AVVERTENZA	
	<p>Pericolo di incidenti in caso di mancata osservanza delle avvertenze di sicurezza generali</p> <ul style="list-style-type: none"> ▶ È solo consentito utilizzare le opzioni di collegamento, i fori di fissaggio e i mezzi di fissaggio previsti. ▶ Montaggio e smontaggio solo ammessi in condizioni di assenza di pressione. ▶ Quando lavora sul dispositivo di sollevamento, l'operatore deve fare in modo di evitare l'accesso al mezzo di trasporto o di sollevamento utilizzato (gru, paranco a catena, veicolo di cantiere, ...), in modo da escludere qualsiasi movimento.

- ▶ I lavori di installazione, manutenzione e riparazione possono essere effettuati unicamente da personale tecnico e meccanici qualificati: in virtù delle loro conoscenze e della loro esperienza, così come della conoscenza delle disposizioni vigenti in materia, essi sono infatti in grado di valutare i lavori loro assegnati, di riconoscere possibili pericoli e di attuare le misure di sicurezza appropriate!
- ▶ È perentorio osservare le disposizioni generali di sicurezza così come le norme EN!
- ▶ Le persone e gli animali non possono trattenersi nella zona di pericolo!
- ▶ Il dispositivo di sollevamento dovrà essere utilizzato unicamente per lo scopo previsto (cap. 1.9).
- ▶ Con il dispositivo di sollevamento possono essere sollevati e trasportati carichi idonei.
- ▶ Entro il campo di lavoro del dispositivo di sollevamento, voi siete i responsabili nei confronti di terzi, pertanto è doveroso definire chiaramente nel sistema e rispettare le competenze previste per le diverse attività. Garantire sempre una chiara suddivisione delle competenze.
- ▶ Il dispositivo di sollevamento non dovrà mai essere utilizzato per aspirare liquidi o materiali fusi.
- ▶ Le singole parti del dispositivo di sollevamento vanno generalmente protette da danni di qualsiasi natura!



AVVERTENZA



Pericolo di incidenti in caso di mancata osservanza delle avvertenze di sicurezza generali

Danni a persone / impianti / sistemi

- ▶ I limiti di carico ammessi sono definiti nel capitolo "Dati tecnici" e non possono essere superati né in eccesso né in difetto.
- ▶ I dispositivi di sicurezza devono essere in condizioni impeccabili e adeguati o adattati al processo specifico.



AVVERTENZA



Pericolo di lesioni a causa di punti di aspirazione del vuoto aperti

- ▶ Non avvicinare gli occhi, le orecchie o qualsiasi altro orifizio del proprio corpo ai punti di aspirazione, né introdurre le mani.
- ▶ L'apparecchio genera un risucchio molto forte, in grado di aspirare capelli e indumenti.



Attenersi in ogni momento alle leggi e alle normative vigenti.

Durante l'utilizzo del dispositivo di sollevamento occorre osservare le leggi, le disposizioni di sicurezza, le norme e le direttive vigenti nel luogo di utilizzo, richiedendole all'occorrenza alle autorità competenti.

Le avvertenze di sicurezza contenute nel presente manuale operativo e di manutenzione non intendono sostituirlle, bensì sono da considerarsi come integrazione.

1.7 Sicurezza durante l'esercizio

1.7.1 Generale



Vietato

- ▶ **L'apparecchio deve essere utilizzato solo in prossimità del terreno.**

Il carico aspirato deve essere abbassato immediatamente dopo il prelievo (ad es. da un pallet o da un camion) fino a poco sopra il suolo (ca. 20 - 30 cm). Il carico viene quindi fissato dalla catena di fissaggio del carico e può essere trasportato solo in seguito al luogo di installazione. Per trasportare il carico, sollevarlo solo se necessario (consigliato a ca. 0,5 m dal suolo). **Non sollevare l'apparecchio sopra la testa delle persone!!!**



- ▶ La movimentazione manuale è consentita solo nel caso di apparecchi dotati di maniglie.
- ▶ L'operatore non deve abbandonare la postazione di comando finché l'apparecchio è carico e deve costantemente sorvegliare il carico.
- ▶ L'utilizzatore deve tenere sempre sotto controllo il manometro. Il carico (ad es. Lastra in pietra) può essere sollevato solo quando sia stata raggiunta la depressione vacuum necessaria. Quando l'indicatore del manometro si trova nella zona rossa al di sotto del livello di depressione necessario, **abbassare subito il carico. Pericolo per la vita – il carico potrebbe cadere!**



Vietato

- Durante l'esercizio è vietata la sosta di persone nel raggio operativo dell'apparecchio! È fatta eccezione per quei casi in cui ciò risulti necessario per la tipologia di utilizzo dell'apparecchio, ad es. se si rende necessaria la sua movimentazione manuale (tramite le maniglie).



- Durante l'utilizzo dell'apparecchio assicurarsi che non vi sia nessuno nell'area di lavoro. **Pericolo di vita!**
- Non tirare o trascinare mai il carico obliquamente.
- La sosta al di sotto del carico sollevato è vietata. **Pericolo di morte!**
- Rilasciare il carico dal piatto solo quando questo si trova completamente posizionato a terra in modo sicuro.

Tenere lontane le dita dal carico. Pericolo che le mani restino schiacciate!



Vietato

- La portata e la larghezza nominale dell'apparecchio non devono essere superate.
- Non utilizzare l'apparecchio per disincagliare dei carichi.
- **E' vietato il sollevamento o l'abbassamento brusco** per l'apparecchio con o senza carico! Evitare vibrazioni inutili. Proprio come la guida veloce con il vettore / paranco su terreni irregolari!

Pericolo di morte: Il carico potrebbe cadere o i dispositivi di movimentazione del carico potrebbero danneggiarsi! In generale, viaggiare solo a **velocità di marcia** con il carico sollevato!

1.8 Pericoli speciali





Vietato



- ▶ Proteggere la zona operativa affinché non possano accedervi le persone non autorizzate, in particolare i bambini.
- ▶ Illuminare adeguatamente la zona operativa.
- ▶ Prestare attenzione in caso di movimentazione di materiali umidi, ghiaccio o sporchi.
- ▶ Fare attenzione in caso di temporali!
- ▶ **E' vietato utilizzare l'apparecchio in condizioni atmosferiche sfavorevoli, ad es. con temperatura al di sotto di 3 °C. Le tracce di umidità o di ghiaccio comportano il rischio di scivolamento del materiale trasportato.**
- ▶ Poiché il carico è trattenuto dal vuoto sulle piastre di aspirazione dell'unità, cade non appena il vuoto crolla (ad esempio in caso di mancanza di corrente elettrica).
- ▶ Se possibile, far cadere immediatamente il carico in caso di guasto. In caso contrario, allontanarsi immediatamente dall'area di pericolo. **pericolo di vita**

1.9 Utilizzo conforme

Il dispositivo di sollevamento viene utilizzato per il sollevamento e il trasporto a poca distanza dal suolo (vedi capitolo "Sicurezza durante l'esercizio") di lastre di pietra piatte, dense e non porose di granito, marmo, WET CAST ecc., così come di elementi in calcestruzzo, pietra naturale, gradini di arenaria, tubi di grès porcellanato, ecc. (qualora sia raggiungibile una depressione di -0,6 bar) con l'ausilio di mezzi di trasporto o sollevamento idonei (gru, paranco a catena, veicoli di cantiere, ...).

 AVVERTENZA	
	<p>Pericolo di caduta di oggetti a causa dell'utilizzo di una piastra di aspirazione non idonea.</p> <ul style="list-style-type: none"> ▶ La piastra di aspirazione non rientra nel volume di fornitura. L'operatore dovrà dunque garantire l'utilizzo di piastre di aspirazione che siano idonee al carico da sollevare. Portata max. 600 kg. ▶ Il fissaggio della piastra di aspirazione deve corrispondere ai requisiti di cui al cap. 5.3 . È vietato qualsiasi tipo di fissaggio diverso delle piastre di aspirazione. ▶ La superficie di aspirazione del carico da sollevare deve presentare vuoto di tenuta, vale a dire una volta scollegata l'alimentazione elettrica, il carico applicato deve poter essere sorretto per altri 5 minuti. Ciò va eventualmente assicurato mediante tentativi.

Il carico (lastra in pietra) che deve essere aspirato e sollevato, deve avere una stabilità inerente sufficiente, in caso contrario sussiste il **rischio di rottura** durante il sollevamento!

Le lastre in pietra **non devono** piegarsi durante il sollevamento – fate particolare attenzione a lastre in pietra larghe e sottili!



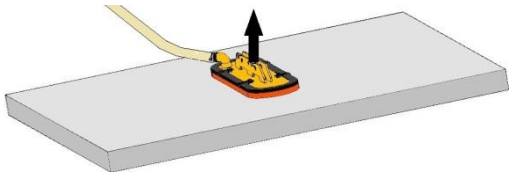

In generale, i carichi (lastre di pietra) possono essere risucchiati solo centralmente, altrimenti il carico viene appeso obliquamente sull'apparecchio, il che può portare alla rottura del carico - specialmente quando si sollevano lastre di pietra di grande formato con una piccola piastra di aspirazione.

Le piastre di aspirazione standard non sono adatte al trasporto di lastre di vetro! adatti per il trasporto di lastre in vetro!





PERICOLO

	<p>Le piastre di aspirazione presentano capacità di carico diverse</p> <p>Pericolo: il carico (lastra in pietra) potrebbe cadere!</p> <ul style="list-style-type: none"> ▶ Alcuni piatti di aspirazione che possono essere montati all'apparecchio ne riducono la capacità di portata. <i>Il carico massimo è indicato su ogni piatto.</i> Utilizzare solo piatti di aspirazione approvati per questo apparecchio! Si possono utilizzare solamente piatti prodotti da Probst!!! ▶ Non superare la capacità di portata massima dei piatti di aspirazione!!! Pericolo: il carico (lastra in pietra) potrebbe cadere!
--	------------------------------------------------------------------------------------------------------------------------------------------------------------------------------------------------------------------------------------------------------------------------------------------------------------------------------------------------------------------------------------------------------------------------------------------------------------------------------------------------------------------------------------------------------------------------------------------------------------------------------------------------------------------------------------------------------







Il dispositivo di sollevamento viene fornito senza piastra di aspirazione.

Il cliente è dunque tenuto a seguire una procedura di valutazione della conformità ai sensi dell'art. 12 della Direttiva macchine 2006/42 (v. anche cap. 5.3).

I limiti di carico ammessi sono definiti nel capitolo 3 ("Dati tecnici") e non possono essere superati né in eccesso né in difetto. A tale riguardo, si prega inoltre di osservare la targhetta segnaletica ovvero l'etichetta che indica la capacità di carico!

È vietato sottoporre il dispositivo di sollevamento a qualsiasi modifica o rifacimento arbitrario: esso può solo essere messo in funzione nelle sue condizioni di fornitura originarie.

AVVERTENZA	
 	<p>Sussiste il pericolo di schiacciamento di parti del corpo o di lesioni mortali a causa della caduta di carichi.</p> <p>Eventuali modifiche o alterazioni arbitrarie non autorizzate compromettono la necessaria integrità del dispositivo di sollevamento. In tal caso, il suo funzionamento non sarebbe più garantito.</p> <p>▶ Non effettuare modifiche al sistema</p>

AVVERTENZA	
 	<p>Pericolo di morte a causa di caduta in caso di utilizzo come mezzo di trasporto per persone, animali o come mezzo di sollevamento.</p> <p>Fratture ossee, lesioni gravissime o addirittura la morte possono esserne gli effetti.</p> <p>▶ È vietato servirsi del dispositivo di sollevamento come mezzo di sollevamento o per il trasporto di persone e animali!</p>

1.10 Obblighi dell'operatore

Il dispositivo di sollevamento può essere installato, mantenuto e riparato esclusivamente da specialisti e meccanici qualificati.



Per specialista si intende: chiunque, in virtù della propria formazione tecnica, delle proprie conoscenze ed esperienze, così come delle conoscenze delle disposizioni vigenti in materia, sia in grado di valutare i lavori affidatigli, di riconoscerne i pericoli e di attuare le misure di sicurezza appropriate. Uno specialista dovrà rispettare le norme tecniche pertinenti applicabili.



L'utilizzo a cura dell'operatore dovrà garantire - mediante misure aziendali - che qualsiasi persona incaricata dall'operatore dell'installazione, della messa in funzione, del comando, della riparazione e manutenzione del dispositivo di sollevamento, affidi tali lavori esclusivamente a persone assicurate

- che abbiano compiuto il 18° anno di età e siano idonei fisicamente e mentalmente,
- che abbiano ricevuto istruzioni in merito alla gestione o alla manutenzione del dispositivo di sollevamento,
- che abbiano letto e compreso il manuale operativo e di manutenzione,
- che siano in grado di svolgere i lavori loro affidati in modo coscienzioso.



Il manuale operativo e di manutenzione deve essere accessibile in ogni momento ed essere conservato per consultazioni future.

 AVVERTENZA	
 	<p>Pericolo di lesioni per applicazioni erranee o mancata osservanza dei cartelli di avvertimento e sicurezza.</p> <ul style="list-style-type: none"> ▶ Utilizzo esclusivamente a cura di personale addestrato. ▶ Regolamento delle pause in conformità alle disposizioni locali, con il fine di evitare incidenti dovuti a mancanza di attenzione.

- Prima di ogni utilizzo, il dispositivo di sollevamento deve essere controllato onde verificarne il corretto funzionamento e le condizioni (v. cap. 0).
- Lavori di manutenzione, lubrificazione e risoluzione degli errori possono solo avvenire a dispositivo spento!
- In caso di difetti che compromettano la sicurezza, il dispositivo di sollevamento può essere rimesso in funzione solo dopo un'esauriva rimozione dei difetti.
- In presenza di crepe sugli elementi portanti, astenersi immediatamente dall'utilizzo del dispositivo di sollevamento.
- Le istruzioni operative del dispositivo di sollevamento devono essere consultabili in ogni momento sul luogo di utilizzo.
- La targhetta segnaletica apposta al dispositivo di sollevamento non può essere rimossa.
- Sostituire qualsiasi cartello di avvertenza non più leggibile.

1.11 Requisiti per il luogo di installazione/di lavoro

1.11.1 Requisiti per il luogo di installazione

 PERICOLO	
	<p>Elementi di comando non protetti contro il rischio di esplosioni</p> <p>Pericolo di incendio ed esplosione</p> <ul style="list-style-type: none"> ▶ È vietato sottoporre il dispositivo di sollevamento a qualsiasi modifica o rifacimento arbitrario.

 AVVERTENZA	
	<p>Pericolo di esplosione a causa dell'aspirazione di sostanze infiammabili</p> <p>▶ Prima di installare il dispositivo di sollevamento, assicurarsi che esso non possa aspirare alcuna sostanza infiammabile (carburanti, solventi, ecc.).</p>

ATTENZIONE	
	<p>Danni al dispositivo di sollevamento dovuti all'utilizzo in aree con sostanze contenenti acidi o alcali ovvero con un'atmosfera inquinata.</p> <p>▶ Prima di utilizzare il dispositivo in un ambiente con un'atmosfera aggressiva, consultare il produttore.</p>

Il dispositivo di sollevamento può essere operato in un range di temperatura compreso tra 3 °C e +40 °C.

ATTENZIONE	
	<p>Danni al dispositivo di sollevamento a causa dell'utilizzo al di fuori del range di temperature ammesso</p> <p>▶ Utilizzare il dispositivo di sollevamento solo entro le temperature</p> <p>▶ Prima di utilizzare il dispositivo al di fuori del range di temperature ammesse, consultare il produttore.</p>

1.11.2 Requisiti per il luogo di lavoro

Il luogo di lavoro dell'operatore coincide con la maniglia di appoggio. Accertarsi che l'operatore possa monitorare in ogni momento l'intero campo di lavoro. Il luogo di lavoro deve essere illuminato a sufficienza e non abbagliare l'operatore.



Mediante indicazioni e controlli aziendali pertinenti, fare in modo che l'ambiente di lavoro sia sempre organizzato in modo ordinato e pulito.

ATTENZIONE	
	<p>Danni al dispositivo di sollevamento a causa dell'aspirazione di piccoli oggetti</p> <p>▶ Il luogo di utilizzo e l'ambiente in cui si opera con il dispositivo di sollevamento vanno mantenuti sgombri da piccoli oggetti che possono essere risucchiati.</p>

1.12 Definizione della zona di pericolo

- Per zona di pericolo s'intende la zona all'interno o nel raggio di un mezzo di lavoro, in cui la sicurezza o la salute delle persone che vi si trattengono è o può essere messa a repentaglio.
- Quando si solleva o si trasporta un carico, sussiste la possibilità che questo cada dal dispositivo di sollevamento o che venga abbassato. In linea di massima, dunque, la zona immediatamente al di sotto del dispositivo di sollevamento è considerata pericolosa.
- Durante il trasporto orizzontale occorre considerare che quando si solleva il carico, si accelera o si frena, hanno luogo, ad esempio, rotazioni, disallineamenti o movimenti oscillatori del carico. Ne consegue che anche l'ambiente attorno al carico è da considerarsi una zona di pericolo.



- Di conseguenza, anche quando si manovra il carico attraverso il posatore, occorre mantenere una certa distanza di sicurezza (servirsi sempre della maniglia per condurre il carico).
- Non posizionarsi mai davanti al carico – in presenza di un ostacolo imprevisto, ad esempio, sussiste il pericolo di inciampare, nel qual caso il carico vi travolgerebbe. Anche quando si arresta il movimento di marcia orizzontale, il carico oscilla nella vostra direzione. In tal caso, non è possibile osservare/monitorare allo stesso tempo il tragitto del trasporto e il carico.
- La zona di pericolo durante una caduta del carico dipende principalmente dall'altezza di trasporto ed è difficilmente valutabile. In linea di massima, mantenere sempre i carichi il più possibile vicini al pavimento.

 AVVERTENZA	
	<p>Pericolo di lesioni a causa della caduta di oggetti quando</p> <ul style="list-style-type: none">- la depressione viene meno- il carico fuoriesce dal controllo in seguito a collisione- i componenti non funzionano più correttamente a causa di sovraccarico o carico scorretto o per modifiche non autorizzate. <p>Le persone vengono colpite e ferite o travolte con gravi lesioni!</p> <ul style="list-style-type: none">▶ Delimitare completamente il luogo di lavoro onde evitare l'accesso di persone non autorizzate, in particolare bambini.▶ Prima di ogni procedura di trasporto, assicurare il carico con l'apposita catena.▶ È vietato soffermarsi sotto carichi sospesi.▶ Lavorare solo in presenza di buona visibilità sull'intero ambiente di lavoro.▶ Prestare attenzione a qualsiasi persona che sia presente nella zona di▶ Non trasportare mai i carichi sorvolando persone.▶ Il baricentro del carico deve trovarsi in ogni momento entro la zona di lavoro del mezzo di trasporto/sollevamento (gru, paranco a catena, veicolo di cantiere, ...).▶ Non rilasciare la maniglia del dispositivo di sollevamento finché c'è un▶ L'operatore/il gestore è tenuto a delimitare la zona di lavoro. Le persone o le attrezzature necessarie a tale scopo devono essere rese disponibili durante la procedura di trasporto/sollevamento.

1.13 Emissioni



Il dispositivo di sollevamento emette rumori e aria di scarico.

Il livello sonoro equivalente emesso dal dispositivo è inferiore a 70 dB(A).

 ATTENZIONE	
 	<p>Inquinamento acustico del generatore di vuoto</p> <p>L'inquinamento acustico può provocare danni all'udito.</p> <ul style="list-style-type: none"> ▶ Indossare una protezione per l'udito

Le sostanze aspirate vengono polverizzate e distribuite dal generatore di vuoto. Di conseguenza, non è consentito aspirare aria ambiente inquinata o contaminata (dimensioni particelle max. 5µm).

 ATTENZIONE	
	<p>Pericolo di avvelenamento da emissioni di gas di scarico risucchiati.</p> <ul style="list-style-type: none"> ▶ Prima di accendere il dispositivo di sollevamento, assicurarsi che esso non possa aspirare alcun gas di scarico.

 ATTENZIONE	
	<p>Pericolo di lesioni agli occhi</p> <p>Tutti i generatori di vuoto danno luogo a un flusso di aria di scarico. In funzione della purezza dell'aria ambiente, quest'aria può contenere particelle che fuoriescono ad alta velocità dall'apertura dell'aria di scarico, ferendo persone nella zona del volto e degli occhi</p> <ul style="list-style-type: none"> ▶ Non guardare nell'apertura dell'aria di scarico. ▶ Indossare occhiali di protezione.

1.14 Dispositivi di protezione individuale

Indossare sempre i dispositivi di protezione idonei!

1.14.1 Installazione/messa fuori servizio e smaltimento del dispositivo di sollevamento

- Calzature di sicurezza (ai sensi di EN 20345 Categoria di sicurezza S1 o superiore)
- Robusti guanti di lavoro (ai sensi di EN 388 Categoria di sicurezza 2133 o superiore)
- Casco di protezione (ai sensi di EN 397)
- Protezione per l'udito (ai sensi di EN 352 Categoria L o superiore)
- Altri dispositivi di protezione prescritti in base alla situazione specifica o da disposizioni a livello nazionale.

1.14.2 Azionamento del dispositivo di sollevamento

- Calzature di sicurezza (ai sensi di EN 20345 Categoria di sicurezza S1 o superiore)
- Robusti guanti di lavoro (ai sensi di EN 388 Categoria di sicurezza 2133 o superiore)
- Casco di protezione (ai sensi di EN 397)
- Altri dispositivi di protezione prescritti in base alla situazione specifica o da disposizioni a livello nazionale.

1.14.3 Eliminazione dei guasti/Manutenzione del dispositivo di sollevamento

- Calzature di sicurezza (ai sensi di EN 20345 Categoria di sicurezza S1 o superiore)
- Robusti guanti di lavoro (ai sensi di EN 388 Categoria di sicurezza 2133 o superiore)
- Occhiali di protezione (Categoria F)
- Protezione per l'udito (ai sensi di EN 352 Categoria L o superiore)
- Altri dispositivi di protezione prescritti in base alla situazione specifica o da disposizioni a livello nazionale.

2 Descrizione del prodotto

2.1 Componenti

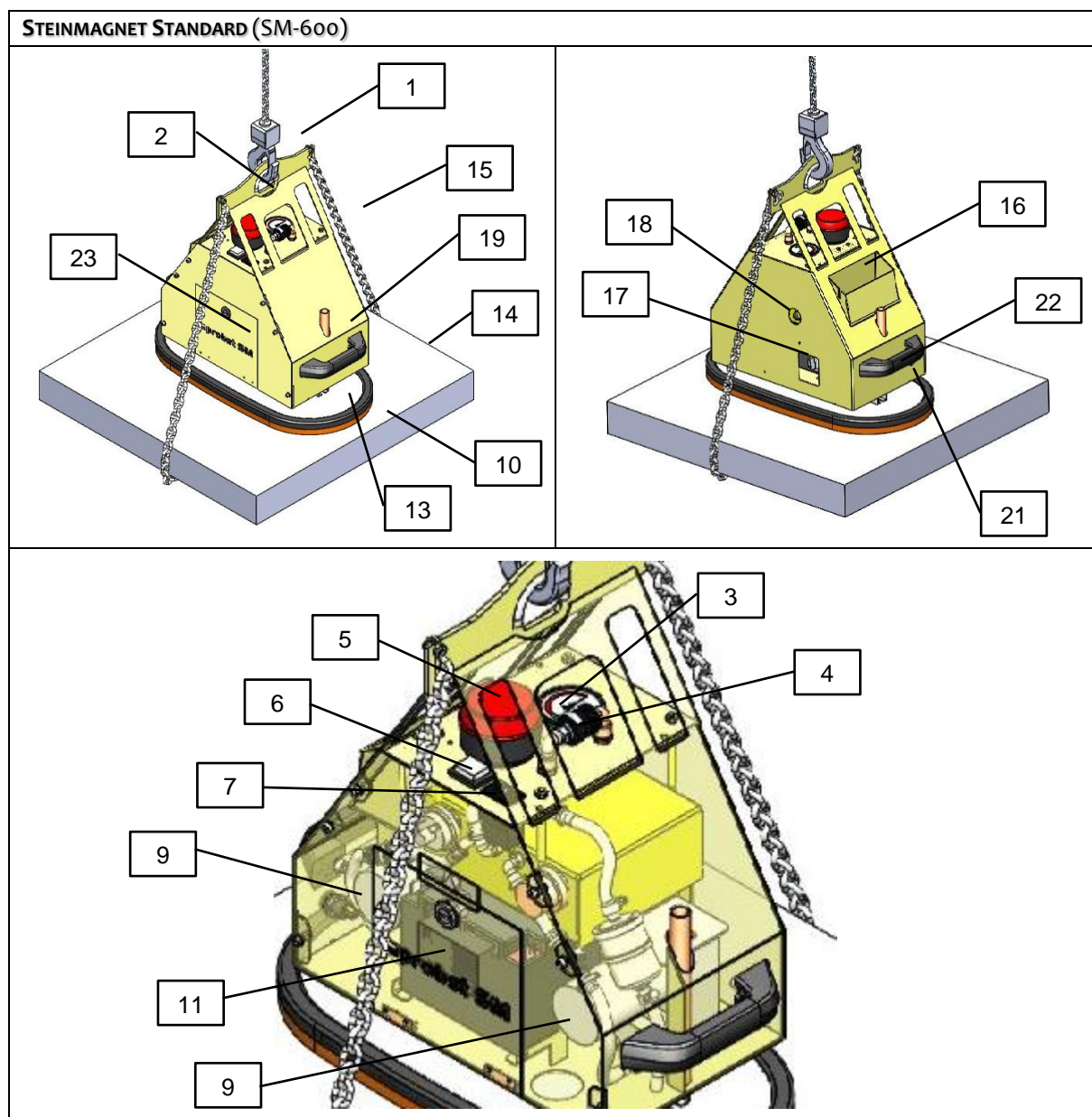

Voce	Descrizione	Voce	Descrizione
1	Gancio per gru (non fornito in dotazione)	12	Filtro antisporcio
2	Anello di sospensione	13	Guida a C della piastra di aspirazione (non fornita in dotazione)
3	Manometro del vuoto	14	Carico (lastra di pietra)
4	Valvola a saracinesca manuale	15	Catena per il fissaggio del carico
5	Spia lampeggiante rossa	16	Custodia per catena
6	Interruttore generale (a 3 posizioni)	17	Valvola di scarico
7	Indicatore livello di carica batteria	18	Spioncino
8	Alloggiamento con deposito di sicurezza	19	Foro di fissaggio piastra di aspirazione
9	Pompe a vuoto	21	Presa di carica
10	Piastra di aspirazione (non fornita in dotazione)	22	Maniglia di appoggio
11	Batteria	23	Coperchio dispositivo

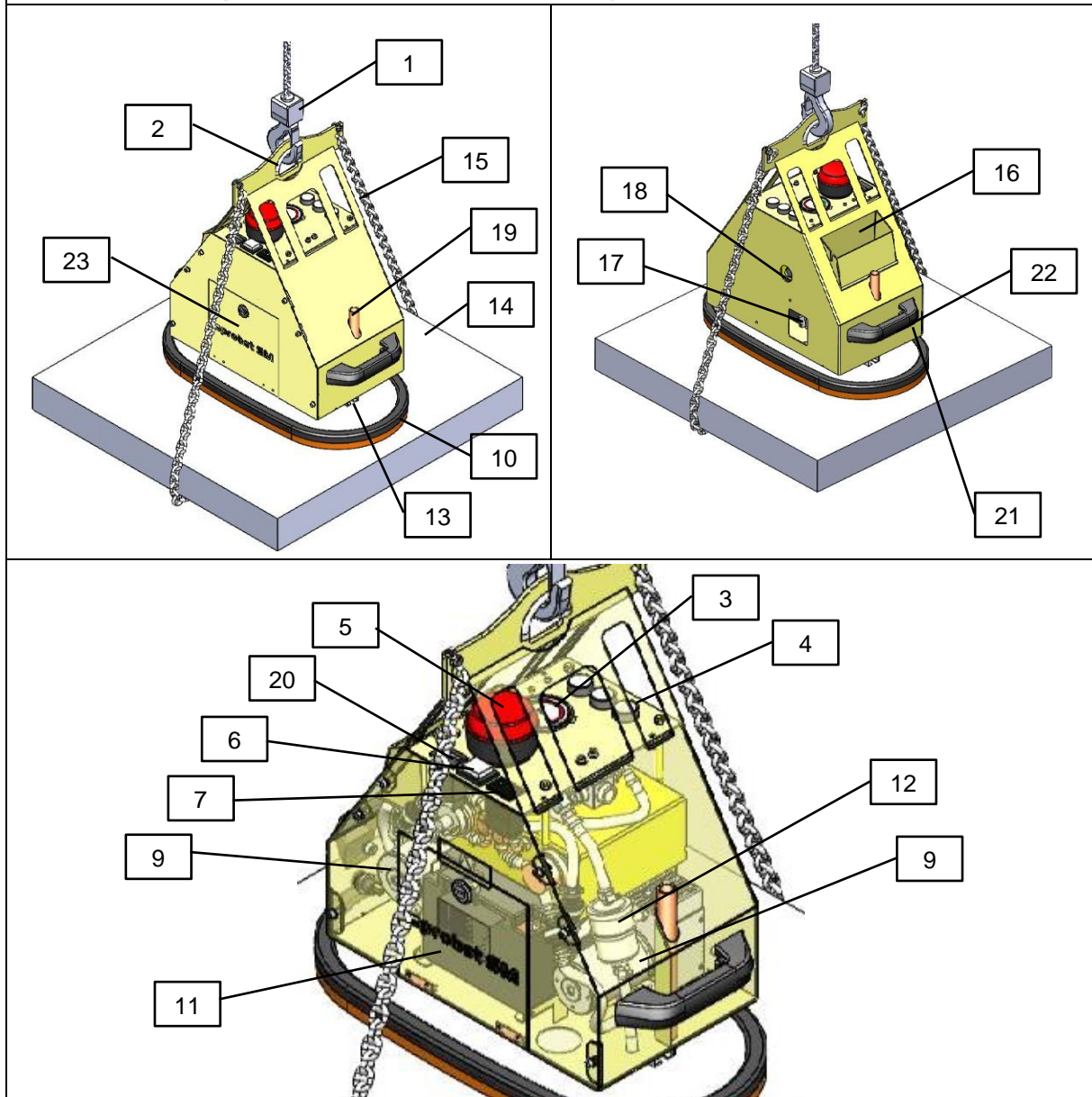
STEINMAGNET POWER (SM-600-POWER / SM-600-POWER-FFS)

Voce	Descrizione	Voce	Descrizione
1	Gancio per gru (non fornito in dotazione)	13	Guida a C della piastra di aspirazione (non fornita in dotazione)
2	Anello di sospensione	14	Carico (lastra di pietra)
3	Manometro del vuoto	15	Catena per il fissaggio del carico
4	Pulsante di azionamento	16	Custodia per catena
5	Spia lampeggiante rossa	17	Valvola di scarico
6	Interruttore generale (a 3 posizioni)	18	Spioncino
7	Indicatore livello di carica batteria	19	Foro di fissaggio piastra di aspirazione
8	Alloggiamento con deposito di sicurezza	20	Contatore ore di esercizio
9	Pompe a vuoto	21	Presa di carica
10	Piastra di aspirazione (non fornita in dotazione)	22	Maniglia di appoggio
11	Batteria	23	Coperchio dispositivo
12	Filtro antispurco		

2.2 Elementi di comando

Steinmagnet Standard SM-600-POWER	Steinmagnet Power SM-600-POWER SM-600-POWER-FFS
--------------------------------------	------------------------------------------------------

Aspirazione del carico

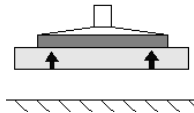

<p>Pulsante di blocco</p>		<p>Opzione radiocomando a distanza</p>
<p>Per spostare la valvola a saracinesca manuale, mantenere premuto contemporaneamente il pulsante di blocco!</p>		

Rilascio del carico

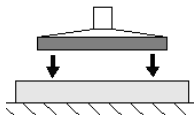

<p>Pulsante di blocco</p>		<p>Opzione radiocomando a distanza</p>
<p>Per spostare la valvola a saracinesca manuale, mantenere premuto contemporaneamente il pulsante di blocco!</p>		<p>Per rilasciare il carico, premere contemporaneamente entrambi i pulsanti.</p>

2.3 Targhetta segnaletica



La targhetta segnaletica funge da identificazione del dispositivo. Le informazioni su essa riportate sono da indicarsi sempre in caso di ordinazioni di ricambi, richieste di garanzia e altre richieste che riguardano l'apparecchio. La targhetta segnaletica è applicata sull'esterno del dispositivo di sollevamento, a cui è avvitata saldamente.

La targhetta segnaletica riporta i dati seguenti:

- Tipo dell'apparecchio
- Num. articolo
- Num. incarico
- Numero di serie
- Anno di fabbricazione
- Peso netto
- Capacità di carico
- Tensione

2.4 Generatore di vuoto

Per la creazione del vuoto, premere l'interruttore generale per attivare una o due pompe a vuoto.

1 pompa a vuoto: maggior durata di funzionamento della batteria

2 pompe a vuoto: tempo di aspirazione più breve e maggior portata d'aria

Se la depressione scende a $-0,53$ bar, le pompe a vuoto si inseriscono automaticamente per riportare la depressione a $-0,66$ bar.

2.5 Piastre di aspirazione

Le piastre di aspirazione (non fornite in dotazione) fungono da aspirazione del carico (v. anche cap. 5.3).

Solo gli oggetti con una superficie liscia e compatta sono idonei per il sollevamento con questo dispositivo.

2.6 Dispositivi di sicurezza

Il dispositivo di sollevamento è dotato dei seguenti dispositivi di sicurezza

- ⇒ Spia lampeggiante rossa (monitora il vuoto d'esercizio ed eventuali black-out)
- ⇒ Interruttore del vuoto
- ⇒ Manometro con indicatore rosso della zona di pericolo
- ⇒ 1 deposito del vuoto
- ⇒ Catena per il fissaggio del carico

Verificare i dispositivi di sicurezza (consultare gli intervalli per la manutenzione nel cap.9.2).

3 Dati tecnici

	Standard SM-600	Power SM-600-POWER /-POWER-FFS
Capacità di carico max.*	600 kg	
Peso netto (senza piastra di aspirazione)	ca. 34 kg	ca. 35 kg
Volume deposito di sicurezza	ca. 2,5 l	
Potenza di aspirazione della pompa a vuoto		
Posiz. interruttore 1 (1 pompa in funzionamento)	29 l/min.	52 l/min.
Posiz. interruttore 2 (2 pompe in funzionamento)	58 l/min.	104 l/min.
Pressione finale max.	Vuoto: 500 mbar	
Range di temperatura per l'utilizzo	da +3 °C a 40 °C	
Tensione	12 V DC	
Corrente assorbita		
Posiz. interruttore 1 (1 pompa in funzionamento)	3,8 A	4,5 A
Posiz. interruttore 2 (2 pompe in funzionamento)	7,6 A	9,0 A
Sostanza pompata	Aria ambiente	



*) La capacità di carico massima del dispositivo di sollevamento dipende dalla piastra di aspirazione (non fornita in dotazione, v. anche cap. 5.3)



PERICOLO

Pericolo di incidente a causa del superamento della capacità di carico

La capacità di carico ammessa per il dispositivo di trasporto e sollevamento (ad es. gru, paranco a catena, veicolo di cantiere, ...) e dello strumento di sollevamento deve essere superiore o almeno uguale alla somma tra il peso netto e la capacità di carico del dispositivo di sollevamento!

3.1 Dati tecnici di telecomando (solo SM-600-POWER-FFS)

	Power SM-600-POWER-FFS
Banda di frequenza	2405-2480 MHz
Numero di canali	16 (canali 11-26)
Codice IP	67
Temperatura di funzionamento	-20 – +55 °C / -4 – +130 °F

4 Consegna, imballaggio e trasporto

4.1 Consegna

4.1.1 Fornitura

L'esatto volume di fornitura è da evincersi dalla conferma dell'ordine. I pesi e le dimensioni sono elencati nei documenti di consegna.



Il manuale operativo e di manutenzione forma parte integrante del dispositivo di sollevamento e deve sempre accompagnarlo ad ogni spostamento del dispositivo.

4.1.2 Verifica dell'integrità

Verificare l'intera spedizione sulla scorta dei documenti di consegna per escludere la mancanza di eventuali componenti!

4.1.3 Notifica di danni

In seguito alla consegna del prodotto, notificare eventuali danni dovuti a imballaggio difettoso o subiti durante il trasporto allo spedizioniere e alla Probst GmbH.





4.2 Imballaggio

Il dispositivo di sollevamento viene consegnato imballato su un bancale.



Il materiale di imballaggio va smaltito in conformità alle leggi e alle direttive vigenti nei singoli Paesi. Rimuovere i fissaggi e le guide per il trasporto.

4.3 Trasporto



 AVVERTENZA	
  	<p>Pericolo di lesioni a causa di trasporto e scarico scorretti</p> <p>Ne derivano danni a persone e a cose.</p> <ul style="list-style-type: none"> ▶ Solo il personale che sia stato addestrato sulla tecnica di sicurezza e sull'uso di carrelli industriali è autorizzato allo scarico e al trasporto del dispositivo. ▶ Utilizzare paranchi e imbracature di dimensioni sufficientemente grandi. ▶ Le merci da trasportare devono essere fissate in conformità alle norme specifiche del Paese (in Germania, le Direttive del BAG, Ufficio federale per il trasporto merci). ▶ Dispositivi di protezione individuale

4.4 Scarico del dispositivo di sollevamento dal bancale

Aprire l'imballaggio con cautela!

Se si utilizzano coltelli o lame per aprirlo, fare attenzione a non danneggiare i componenti.

Estrarre il dispositivo di sollevamento con estrema cautela!

 ATTENZIONE	
 	<p>Componenti pesanti sul bancale</p> <p>Durante l'apertura dell'imballaggio possono essere scivolati e caduti alcuni pezzi. Ciò può provocare contusioni e ferite da taglio.</p> <ul style="list-style-type: none">▶ Indossare calzature di sicurezza (S1), guanti da lavoro (categoria di sicurezza 2133)!

ATTENZIONE	
	<p>Rimozione scorretta del sistema dalla cassa per il trasporto</p> <p>Danneggiamento del sistema</p> <ul style="list-style-type: none">▶ Non esercitare violenza▶ Attenersi alle avvertenze per la rimozione del sistema dalla cassa per il trasporto.

5 Messa in servizio





Prima della prima messa in servizio è necessario che uno specialista qualificato controlli i passaggi descritti di seguito e legga il capitolo 1.10 (Requisiti e avvertenze per il personale operativo, di installazione e manutenzione).

5.1 Elenco degli attrezzi

Per l'installazione non sono richiesti attrezzi.

5.2 Fissaggio del dispositivo di sollevamento

 AVVERTENZA	
 	<p>Pericolo di strappi a causa di montaggio non corretto</p> <p>Le persone vengono ferite o travolte mortalmente da parti che si schiantano!</p> <ul style="list-style-type: none"> ▶ Il dispositivo di sollevamento può solo essere agganciato a un occhiello! ▶ La capacità di carico ammessa per il dispositivo di trasporto e sollevamento (ad es. gru, paranco a catena, veicolo di cantiere, ...) e dello strumento di sollevamento deve essere superiore o almeno uguale alla somma tra il peso netto e la capacità di carico del dispositivo di sollevamento! ▶ Il mezzo di trasporto o sollevamento utilizzato e il paranco devono trovarsi in condizioni impeccabili!

5.3 Montaggio della piastra di aspirazione sul dispositivo di sollevamento

La piastra di aspirazione e il materiale di fissaggio non sono forniti in dotazione.

 PERICOLO	
	<p>Pericolo di incidenti a causa di accensione accidentale.</p> <ul style="list-style-type: none"> ▶ Spegnerne il dispositivo di sollevamento prima di procedere al montaggio della piastra di aspirazione!

 PERICOLO	
	<p>Pericolo di incidenti a causa di materiale di fissaggio non idoneo.</p> <ul style="list-style-type: none"> ▶ La piastra di aspirazione va allestita a cura del cliente a seconda del carico utilizzato (superficie, spessore, peso). Il cliente s'impegna dunque a dimostrare la resistenza statica e le forze di resistenza in funzione del vuoto raggiungibile, così come a rispettare i fattori di sicurezza. In tale ambito va presa come riferimento la norma DIN EN 13155 nella versione di volta in volta applicabile al momento del montaggio. ▶ La piastra di aspirazione deve essere montata utilizzando il materiale di fissaggio idoneo. <ul style="list-style-type: none"> • 2 aste filettate M12 – 4.6, lunghezza 247 mm • 2 ghiera DIN 582 E – M12 – C15 zincate

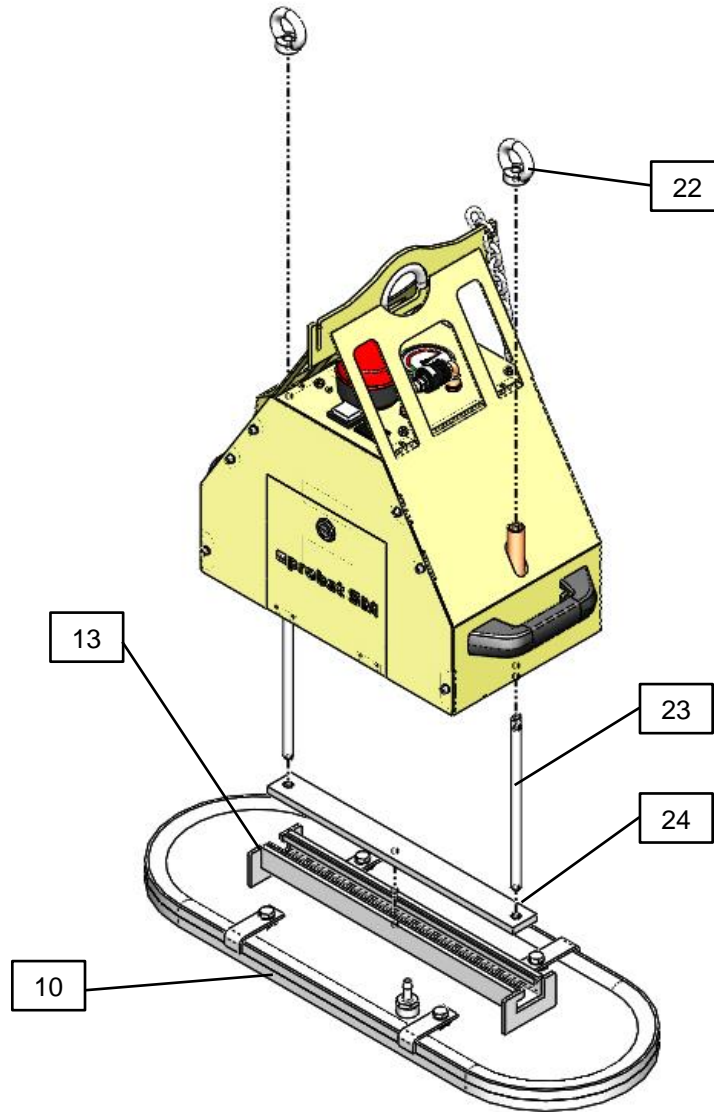

Materiale per il fissaggio della piastra di aspirazione (non fornito in dotazione):

Voce	Descrizione	Voce	Descrizione
10	Piastra di aspirazione	23	Asta filettata
13	Guida a C	24	Dado a T
22	Ghiera		

1. Avvitare le due aste filettate nei dadi a T in modo che l'asta resti completamente avvitata.
2. Introdurre le due aste filettate dal basso nei due fori di fissaggio dell'alloggiamento fino a farle fuoriuscire nella parte superiore dello stesso.
3. Avvitare la ghiera sulle aste filettate solo di 2-3 passi.
4. Far scorrere lateralmente la guida a C della piastra di aspirazione sul dado a T.
5. Centrare la piastra di aspirazione.
6. Serrare le ghiera e verificare che la piastra di aspirazione sia ben salda.
7. Collegare il tubo del vuoto della piastra di aspirazione.
8. Verificare la tenuta (v. cap. 9.5.3).
9. Prima di svolgere lavori con carichi, controllare tutti i dispositivi di sicurezza.



L'installazione del dispositivo di sollevamento si considera conclusa quando si sono terminati con esito positivo almeno 3-4 procedure di prova con un carico. Le prove richieste in Europa ai sensi della norma DIN EN 13155 prima della messa in servizio sono coperte da un esame del modello.

5.4 Sostituzione della piastra di aspirazione

1. Posizionare il dispositivo di sollevamento su una superficie piana e pulita.
2. Spegnerne il dispositivo di sollevamento.
3. Staccare il tubo del vuoto.
4. Allentare le ghiere.
5. Sollevare il dispositivo sorreggendo la piastra di aspirazione.
6. Fissare la nuova piastra di aspirazione al dispositivo di sollevamento (v. cap. 5.3).
7. Conservare la piastra di aspirazione nuova in un luogo idoneo (v. cap. 7).

5.5 Approvvigionamento energetico

Il dispositivo di sollevamento viene alimentato da una batteria integrata. Non è dunque necessario alcun approvvigionamento energetico esterno durante il funzionamento.



Una carica della batteria dura una giornata di lavoro all'incirca.

Per mantenere il dispositivo di sollevamento sempre operativo, ricaricare la batteria dopo ogni utilizzo.

La batteria può essere ricaricata in modo permanente.





In aggiunta, è possibile tenere a portata di mano una batteria di ricambio (consultare il cap. 9.2 per le avvertenze sul cambio batteria).

6 Funzionamento



Avvertenza sulla locazione/concessione:
 in caso di locazione/concessione del dispositivo di sollevamento è perentorio consegnare il manuale operativo originale corrispondente (qualora la consegna avvenisse in un paese dove si parla un'altra lingua, andrà aggiunta una traduzione del manuale originale nella lingua corrispondente)!

6.1 Avvertenze generali di sicurezza relative al funzionamento

 AVVERTENZA	
	<p>Mancata osservanza delle avvertenze generali di sicurezza durante il funzionamento Ne derivano danni a persone e al sistema.</p> <p>▶ Il sistema andrà messo in funzione esclusivamente da personale debitamente formato, che abbia letto e compreso il manuale operativo e di manutenzione.</p>
 AVVERTENZA	
	<p>Pericolo di lesioni a causa di depressione elevata e portata elevata Vengono risucchiati capelli, pelle, parti del corpo e vestiti.</p> <p>▶ Utilizzare indumenti aderenti e indossare retine per i capelli.</p> <p>▶ Non guardare nel raccordo di aspirazione.</p> <p>▶ Non toccare all'interno del raccordo di aspirazione.</p> <p>▶ Non avvicinare ad alcun orifizio del proprio corpo</p>

AVVERTENZA

Vietato
Pericolo a causa della caduta di oggetti

- **quando la depressione viene meno**
- **quando il carico fuoriesce dal controllo in seguito a collisione**
- **quando dei componenti non funzionano più correttamente a causa di sovraccarico o di modifiche non autorizzate**

Le persone vengono colpite e ferite o travolte con gravi lesioni!

- ▶ Nessuno può soffermarsi nell'area di pericolo del carico.
- ▶ Non trasportare mai i carichi sorvolando persone.
- ▶ Prima del trasporto, è necessario allestire dei dispositivi di protezione appropriati.
- ▶ Lavorare solo in presenza di buona visibilità sull'intero ambiente di lavoro.
- ▶ Prestare attenzione a qualsiasi persona che sia presente nella zona di
- ▶ Non rilasciare la maniglia del dispositivo di sollevamento finché c'è un carico sospeso.
- ▶ Non tirare, trascinare o trainare i carichi in obliquo.
- ▶ Non staccare mai i carichi fissi con il dispositivo di sollevamento.
- ▶ Aspirare e sollevare solo carichi idonei (verificandone stabilità e porosità mediante dei tentativi).
- ▶ L'operatore/il gestore è tenuto a delimitare la zona di lavoro. Le persone o le attrezzature necessarie a tale scopo devono essere rese disponibili durante la procedura di trasporto/sovvamento.
- ▶ È vietato superare la capacità di carico ammessa per ogni piastra di aspirazione.
- ▶ Non appoggiare alcun pezzo sul dispositivo di sollevamento.
- ▶ Mentre si manovra il dispositivo, è vietato disattivare il vuoto.

- ▶ **Sollevare e trasportare il carico solo con la catena di sicurezza del carico inserita!**

- ▶ **L'apparecchio deve essere utilizzato solo in prossimità del terreno.**

Il carico aspirato deve essere abbassato immediatamente dopo il prelievo (ad es. da un pallet o da un camion) fino a poco sopra il suolo (ca. 20 - 30 cm). Il carico viene quindi fissato dalla catena di fissaggio del carico e può essere trasportato solo in seguito al luogo di installazione. Per trasportare il carico, sollevarlo solo se necessario (consigliato a ca. 0,5 m dal suolo). **Non sollevare l'apparecchio sopra la testa delle persone!!!**



6.2 Prove da effettuare prima di iniziare il lavoro

 AVVERTENZA	
	<p>Pericolo a causa della caduta di oggetti.</p> <ol style="list-style-type: none"> ▶ 1. Verificare lo stato di carica della batteria (spia pos. 7, per la sostituzione della batteria vedasi il cap. 9.2). <ul style="list-style-type: none"> ○ La batteria è piena quando l'indicatore di stato di carica è verde nei primi 10 secondi dopo l'accensione. ○ Dopo 10 secondi, l'indicatore di stato di carica può diventare GIALLO. ○ Può essere utilizzato il dispositivo di sollevamento. ○ Ricaricare la batteria prima di utilizzare quando l'indicatore di stato di carica è impostato su giallo o rosso quando l'unità è accesa. ○ Una carica di batteria contiene circa un giorno lavorativo. ○ Per mantenere il dispositivo di sollevamento pronto per il funzionamento in qualsiasi momento, la batteria ricaricabile deve essere caricata dopo ogni ciclo di lavoro. ○ La batteria può essere caricata in modo permanente 2. Verificare le condizioni della piastra di aspirazione. 3. Accertarsi che la piastra di aspirazione sia debitamente fissata. 4. Verificare i dispositivi di sicurezza (v. cap. 2.6). 5. Verificare il filtro antispurco e, se necessario, sostituirlo. 6. Verificare l'acqua di condensa e, se necessario, drenarla (v. cap. 9.7). 7. Accertarsi che i mezzi di trasporto e sollevamento utilizzati (gru, paranco a catena, veicoli di cantiere, ...) e il paranco siano idonei (consultare la capacità di carico max. al cap. 3).

6.3 Comportamento in caso d'emergenza

Si ha un'emergenza quando:

- in caso di guasto dell'alimentazione del vuoto (ad es. in caso di black-out → non viene più generato alcun vuoto). In questo caso, un deposito integrato si occupa di mantenere la depressione per un breve periodo di sicurezza (in funzione dello spessore della superficie del carico).
- In caso di fuga (ad es. se si rompe un tubo)
- Al verificarsi di forze in seguito a collisione
- Quando mentre si manovra un carico, il livello del vuoto scende al di sotto di -0,6 bar nella zona rossa del manometro.

 AVVERTENZA	
	<p>Pericolo di lesioni a causa della caduta del livello del vuoto in seguito a black-out o a un guasto della generazione del vuoto</p> <p>Ne derivano contusioni e lesioni gravi.</p> <ol style="list-style-type: none"> ▶ In caso di pericolo, l'operatore è tenuto a lanciare immediatamente ▶ Non accedere mai alla zona di pericolo. ▶ Ove possibile, deporre i carichi in modo sicuro.

6.4 Opzione radiocomando a distanza

Il radiocomando a distanza è stato sottoposto a controllo ed è conforme ai valori limite relativi agli apparecchi digitali della Classe B, ai sensi della parte 15 dei regolamenti FCC. Tali valori limite sono volti a garantire una protezione adeguata dalle interferenze dannose nelle zone residenziali.

Se non viene impiegato secondo le istruzioni, il radiocomando genera, utilizza e irradia onde ad alta frequenza che possono causare interferenze alle comunicazioni via radio.



Ad ogni modo, non è possibile escludere completamente che una determinata installazione generi interferenze. Qualora il radiocomando produca interferenze per la ricezione di radio o TV, constatabili tramite l'accensione e

lo spegnimento del radiocomando stesso, si raccomanda di rimuovere detta interferenza attuando una o più delle seguenti misure:

- Modificare l'orientamento o riposizionare l'antenna di ricezione.
- Aumentare la distanza tra il radiocomando a distanza e il ricevitore.
- Consultare il rivenditore o uno specialista esperto di radio/TV.

 ATTENZIONE	
	<p>Pericolo di lesioni a causa di movimenti incontrollati del dispositivo di sollevamento</p> <ul style="list-style-type: none"> ▶ Tenere sempre sotto controllo il tragitto del trasporto e il carico! Lavorare solo in presenza di buona visibilità sull'intero ambiente di lavoro. ▶ Prima di rimuovere il carico, accertarsi che non vi sia nessuno nella zona di pericolo.

6.5 Sollevamento e aspirazione del carico

 AVVERTENZA	
	<p>Pericolo di lesioni a causa della caduta di carichi</p> <ul style="list-style-type: none"> ▶ Prima di ogni procedura di trasporto, assicurare il carico con l'ausilio dell'apposita catena. ▶ Sollevare il carico solo una volta raggiunto un vuoto pari a -0,6 bar (lancetta del manometro nella zona verde). Attendere lo spegnimento del lampeggiante! In caso contrario, la forza di tenuta sarebbe insufficiente. ▶ Non sollevare né abbassare il carico con movimenti bruschi. ▶ I carichi con superfici umide, bagnate, oleose, ghiacciate, sporche, polverose o in altre condizioni che ne riducano l'attrito, devono essere puliti prima dell'aspirazione! ▶ È vietato superare la capacità di carico ammessa per ogni piastra di aspirazione.
 AVVERTENZA	
	<p>Pericolo di lesioni a causa di movimenti incontrollati del dispositivo di sollevamento</p> <ul style="list-style-type: none"> ▶ Afferrare il carico sempre nel suo baricentro ▶ Il carico deve essere sciolto. ▶ Il carico non deve mai aderire. ▶ Il carico non può presentare spigoli.

Aspirazione del carico

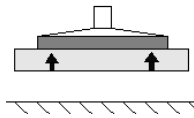

Steinmagnet Standard SM-600

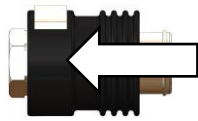

Per spostare la valvola a saracinesca manuale,
mantenere premuto contemporaneamente il pulsante
di blocco!

Steinmagnet Power

SM-600-POWER

SM-600-POWER-FFS



Opzione radiocomando
a distanza



1. Posizionare il dispositivo di sollevamento nell'epicentro del carico.
2. Accertarsi che l'intera superficie della piastra di aspirazione poggia sul carico.
3. Assicurare il carico con l'ausilio dell'apposita catena.
 - Sollevare (ca. 20-30 cm) l'apparecchio con il carico sollevato,
 - prelevare la catena di sicurezza e farla passare sotto al carico.
 - **Non passare mai con le mani al di sotto del carico (lastra)! Pericolo di infortunio alle mani!**
 - agganciare la catena di sicurezza sull'altro lato dell'apparecchio in modo che risulti ben tirata.
 - La catena di sicurezza deve essere posizionata in modo teso (vedi figura seguente), in modo che **in caso di mancanza di vacuum il carico (ad es. in caso manchi la corrente) possa essere trattenuto dalla catena di sicurezza.**
 - La catena di sicurezza non deve mai essere lasciata allentata sotto al carico, altrimenti in caso di mancanza di vacuum (ad es. in caso manchi la corrente) il carico potrebbe cadere!
4. Evitare di tirare il carico in diagonale.
5. Accendere l'approvvigionamento di corrente.
 - Spia in funzionamento fino al raggiungimento di depressione -0,6 bar.
6. Azionare l'elemento di comando (v. Fig. in alto a seconda del modello).
7. Osservare il manometro. Non appena si raggiunge una depressione pari a -0,6 bar (lancetta del manometro nella zona verde), il lampeggiante si spegne e si può sollevare il carico.

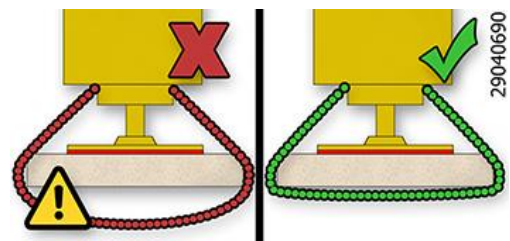

6.6 Conduzione del carico

 AVVERTENZA	
	<p>Pericolo di lesioni a causa di movimenti incontrollati del dispositivo di sollevamento</p> <ul style="list-style-type: none"> ▶ Per condurre il carico, utilizzare la maniglia. Mantenere le distanze di sicurezza. ▶ Tenere sempre sotto controllo il tragitto del trasporto e il carico! Non camminare davanti al carico! Pericolo di inciampare! Quando si arresta il movimento di marcia orizzontale, il carico oscilla nel senso di marcia. ▶ Trasportare i carichi sempre il più vicino possibile al pavimento e adeguare la velocità di trasporto alle condizioni specifiche. ▶ È vietato maneggiare il dispositivo di sollevamento con movimenti bruschi, poiché esso potrebbe iniziare a ruotare e oscillare.

AVVERTENZA	
	<p>Pericolo di lesioni a causa della caduta di carichi</p> <ul style="list-style-type: none"> ▶ Non condurre il dispositivo di sollevamento ad alta velocità su una superficie irregolare con il carico aspirato.

6.7 Deposito e rilascio del carico

AVVERTENZA	
 	<p>Pericolo di lesioni a causa del ribaltamento di parti</p> <ul style="list-style-type: none"> ▶ Abbassare il carico (ca. 20-30 cm dal suolo), rimuovere la catena. Non passare mai con le mani sotto al carico (lastra)! Pericolo per le mani! Riposizionare la catena nelle casta. Prima di allontanare il dispositivo di sollevamento, accertarsi che il carico rimanga in modo sicuro in posizione orizzontale sul pavimento o su una base di appoggio adeguata. ▶ Se necessario, il carico dovrà essere assicurato contro lo scivolamento o il ribaltamento prima di essere rimosso dal dispositivo di sollevamento. ▶ Non appena il carico viene prelevato dalla catena di fissaggio del carico, la catena di fissaggio del carico deve essere controllata professionalmente e, se necessario, sostituita. Le catene di fissaggio del carico danneggiate non devono più essere utilizzate!

Rilascio del carico

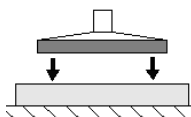

Steinmagnet Standard SM-600	Steinmagnet Power SM-600-POWER SM-600-POWER-FFS	
<div style="border: 1px solid black; padding: 5px; display: inline-block;">Pulsante di blocco</div>		Opzione radiocomando a distanza
Per spostare la valvola a saracinesca manuale, mantenere premuto contemporaneamente il pulsante di blocco!	Per rilasciare il carico, premere contemporaneamente entrambi i pulsanti.	

1. Abbassare il carico e deporlo in modo sicuro su una superficie sgombra e piana,
 2. escludendone un possibile scivolamento o ribaltamento.
 3. Per appoggiarlo, azionare l'elemento di comando (v. Fig. in alto a seconda del modello)
- Il carico viene rilasciato. A questo punto, è possibile sollevare nuovamente il dispositivo di sollevamento.

6.8 Stazionamento del dispositivo di sollevamento

Il parcheggio temporaneo del dispositivo di sollevamento spento si definisce con il termine "stazionamento".

Procedura:

1. disinserire l'approvvigionamento di energia.
2. Ove necessario, drenare l'acqua di condensa (v. cap. 9.7).
3. Agganciare il dispositivo di sollevamento in una posizione sicura sul mezzo di trasporto o sollevamento (non deporlo sul carico!).

7 Stoccaggio

Opzioni per uno stoccaggio corretto in caso di non utilizzo:

- Lasciare il dispositivo di sollevamento appeso o
- in posizione verticale sul pavimento,
IMPORTANTE! Prima di riporlo, smontare la piastra di aspirazione e conservarla separatamente.

ATTENZIONE	
	<p>Danneggiamento della ventosa</p> <p>I dispositivi di aspirazione si deformano, invecchiano prematuramente e non funzionano più correttamente.</p> <p>▶ Stoccaggio dei dispositivi di aspirazione e delle ventose come da raccomandazioni per le parti in materiali elastomerici.</p>

Raccomandazioni per lo stoccaggio di parti in materiali elastomerici

L'effetto di ozono, luce (specialmente i raggi UV), calore, ossigeno, umidità ed effetti meccanici possono accorciare la vita utile dei prodotti in gomma. Si raccomanda pertanto di stoccare le parti in gomma a basse temperature (comprese tra 0 °C e + 15 °C, max. 25 °C, in luogo scuro, asciutto, privo di polvere, protetto dagli agenti atmosferici, dall'ozono e da correnti d'aria e privo di tensione (ad es. impilandole in modo adeguato onde evitarne la deformazione).

Accertarsi che non vi sia acqua di condensa nel deposito (spioncino pos. 18). Ove necessario, drenare l'acqua di condensa (v. cap. 9.7).

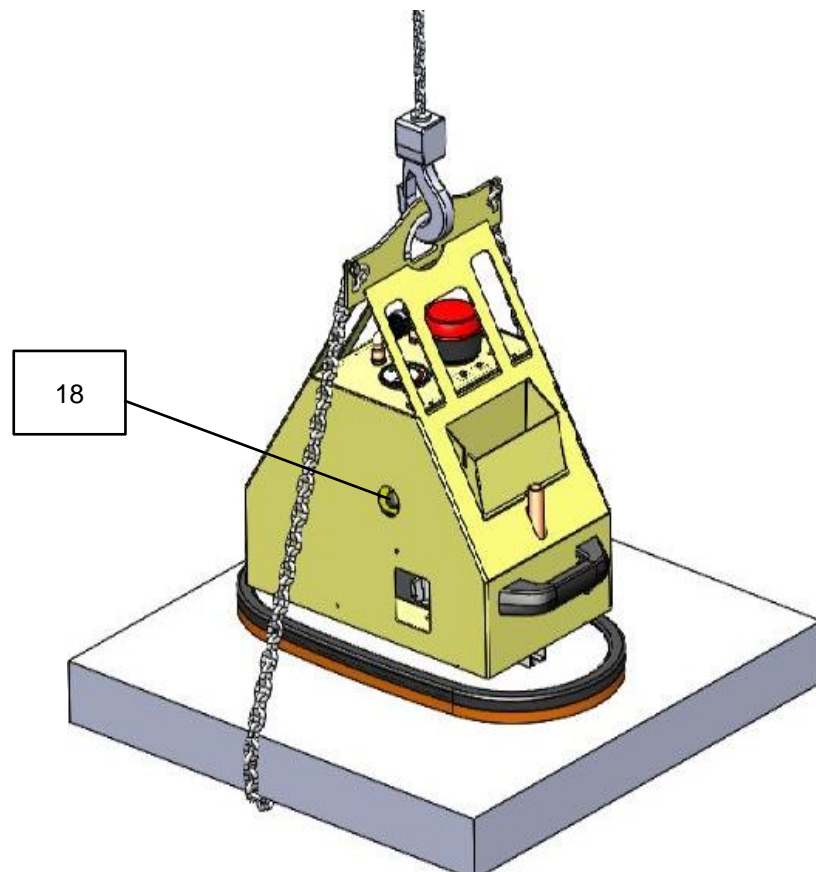

8 Eliminazione dei guasti

Il dispositivo di sollevamento può essere installato, mantenuto e riparato esclusivamente da specialisti e meccanici qualificati. V. capitolo 1.10 Obblighi dell'operatore.



In seguito a lavori di riparazione o manutenzione, non mancare di controllare tutti i dispositivi di sicurezza come descritto nel capitolo "9.5 Controllo dei dispositivi di sicurezza".



Se il carico non può essere sollevato, far scorrere passo passo l'elenco sottostante fino a identificare ed eliminare l'errore.



Errore	Causa	Rimedio
Il generatore di vuoto non funziona	Batteria vuota o difettosa	Caricare o sostituire la batteria (v. cap. 9.2)
	Connettore della batteria non collegato	Collegare il connettore
Il generatore di vuoto funziona, ma non è in grado di raggiungere una depressione di -0,6 bar	La guarnizione della piastra di aspirazione è danneggiata	Sostituire la piastra di aspirazione
	Il carico presenta crepe, incavi o porosità	Non è possibile manovrare il carico con questo dispositivo di sollevamento
	Il manometro è difettoso	Sostituire il manometro
	Tubo flessibile/viti non ermetici	Sostituire/rendere ermetici i componenti
	Interruttore del vuoto in posizione scorretta/difettoso	Contattare il Servizio clienti
	Il filtro è sporco	Ripulire il filtro o sostituirlo
	Filtro non chiuso ermeticamente	Chiudere ermeticamente il filtro
	Tubo flessibile/viti non ermetici	Sostituire/rendere ermetici i componenti
	Interruttore generale in pos. "I" (solo una pompa a vuoto è in funzione)	Portare l'interruttore generale alla pos. "II" (due pompe a vuoto funzionanti)
Il generatore del vuoto funziona ma non aspira	La valvola a saracinesca manuale è in posizione "Rilascia"	Spostare la valvola a saracinesca manuale sulla posizione "Aspira carico"
	Valvola a saracinesca manuale difettosa	Contattare il Servizio clienti
La spia luminosa lampeggia, ma la depressione scende al di sotto di -0,48 bar	Il carico presenta crepe, incavi o porosità	Non è possibile manovrare il carico con questo dispositivo di sollevamento
	La guarnizione è danneggiata	Sostituire la piastra di aspirazione
	Tubo flessibile/viti non ermetici	Sostituire i componenti
	Interruttore del vuoto in posizione scorretta/difettoso	Contattare il Servizio clienti

9 Manutenzione

9.1 Avvertenze generali

Il dispositivo di sollevamento può essere installato, mantenuto e riparato esclusivamente da specialisti e meccanici qualificati. V. capitolo 1.10 Obblighi dell'operatore.

 AVVERTENZA	
	<p>Pericolo di incidenti a causa di manutenzione del sistema eseguita da personale</p> <p>Ne derivano gravi danni a persone</p> <p>► Il sistema andrà messo in funzione esclusivamente da personale debitamente formato, che abbia letto e compreso il manuale operativo e di manutenzione.</p>

 AVVERTENZA	
	<p>Pericolo di incidenti a causa di parti usurate e non sottoposte a manutenzione</p> <p>Parti usurate e non sottoposte a manutenzione possono causare danni che possono comportare il guasto totale del dispositivo di sollevamento come anche gravi incidenti</p> <p>► Mantenere le condizioni di esercizio, manutenzione e riparazione specificate nel presente manuale operativo e di manutenzione.</p>

9.2 Sostituzione della batteria

Quando l'autonomia della batteria inizia ad accorciarsi, è ora di sostituirla.

Procedura:

1. spegnere l'apparecchio.
2. Aprire il coperchio dell'apparecchio (con un cacciavite piatto grande).
3. Staccare la spina di collegamento.
4. Estrarre la batteria.
5. Fissare i cavi dei poli alla nuova batteria, facendo attenzione alla corretta polarità:
ROSSO = POLO POSITIVO
NERO = POLO NEGATIVO
6. Inserire la batteria.
7. Collegare il cavo.
8. Chiudere il coperchio dell'apparecchio e serrarlo con il cacciavite.
9. Smaltire la batteria usata secondo la procedura corretta.



9.3 Generatore di vuoto

Consultare il manuale operativo della pompa a vuoto allegato / (Allegato).

9.4 Piastre di aspirazione / guarnizioni

- Ripulire almeno una volta a settimana le guarnizioni da oggetti aderenti e sporco come sabbia, particelle di pietra, polvere, ecc.
- Pulire la gomma spugnosa con aria compressa e/o un getto d'acqua oppure con acqua insaponata.
- Sostituire immediatamente le piastre di aspirazione danneggiate o usurate (crepate, bucate o con ondature).
- Sostituire sempre la piastra di aspirazione completa!



Suggerimento:
le viti della piastra di aspirazione si rimuovono più facilmente se si riscaldano!

Quando si riavvitano le viti, fare in modo che il collegamento della piastra di aspirazione sia di nuovo ermetico!

9.5 Controllo dei dispositivi di sicurezza

Controllare i dispositivi di sicurezza (v. cap. 2.6) all'inizio di ogni turno di lavoro (in caso di attività interrotta) o una volta alla settimana (in caso di attività ininterrotta).

9.5.1 Controllare la spia lampeggiante

Accendere il generatore del vuoto.

Appoggiare il dispositivo di sollevamento su un carico dalla superficie liscia e compatta e aspirare il carico.

 AVVERTENZA	
	<p>Pericolo di lesioni a causa di caduta di carichi, quando la depressione viene meno</p> <p>Durante il controllo, il carico può staccarsi e cadere.</p> <p>▶ Aspirare il carico solamente, non sollevarlo.</p>

Una volta instaurata la depressione, sollevare leggermente la guarnizione della piastra di aspirazione per simulare una perdita di tenuta.

La depressione sul manometro diminuisce. Quando la depressione scende al di sotto di -0,43 bar, si accende la spia lampeggiante.

 AVVERTENZA	
	<p>Pericolo di lesioni a causa della caduta di carichi</p> <p>▶ L'interruttore del vuoto è impostato di fabbrica e non può in nessun caso essere modificato.</p>

9.5.2 Controllo dei tubi flessibili e dei morsetti di aspirazione

Controllare tutti i tubi flessibili e i morsetti di aspirazione per constatarne la buona tenuta, se necessario serrarli.

9.5.3 Prova della tenuta

Eeguire la prova della tenuta con frequenza mensile.

1. Posizionare le piastre di aspirazione su una superficie liscia e compatta (es. una lastra di lamiera).
2. Accendere il vuoto.
3. Aspirare il carico senza sollevarlo (v. cap. 6.5).

 AVVERTENZA	
	<p>Pericolo di lesioni a causa di caduta di carichi, quando la depressione viene meno</p> <p>Durante il controllo, il carico può staccarsi e cadere.</p> <p>▶ Aspirare il carico solamente, non sollevarlo.</p>

1. Attendere finché la depressione raggiunge -0,6 bar.
2. Spegnerne la pompa a vuoto. La depressione può cadere di massimo 0,1 bar nel giro di 5 minuti.
3. Al termine della prova, rilasciare il carico (v. cap. 0).

Eliminare qualsiasi difetto prima di mettere in funzione l'apparecchio. Se subentra qualsiasi difetto durante il funzionamento, spegnere l'apparecchio ed eliminare il difetto.

9.6 Filtro

Controllare il filtro antisporcio almeno una volta alla settimana. In caso di sporco di grande entità, sostituire il filtro.

Procedura:

1. aprire il coperchio dell'apparecchio.
2. Allentare la fascetta stringitubo ed estrarre il filtro.
3. Introdurre il nuovo filtro e fissarlo con la fascetta.
4. Richiudere il coperchio dell'apparecchio.
5. Verificare la tenuta (v. sopra).

9.7 Drenaggio dell'acqua di condensa

L'umidità rilasciata durante la generazione del vuoto dà luogo ad acqua di condensa. Quest'ultima deve essere drenata almeno una volta al giorno. Se necessario, controllare lo spioncino (18).

Procedura:

1. aprire la valvola di scarico (pos. 17) e far fuoriuscire l'acqua di condensa.
2. Chiudere la valvola di scarico.

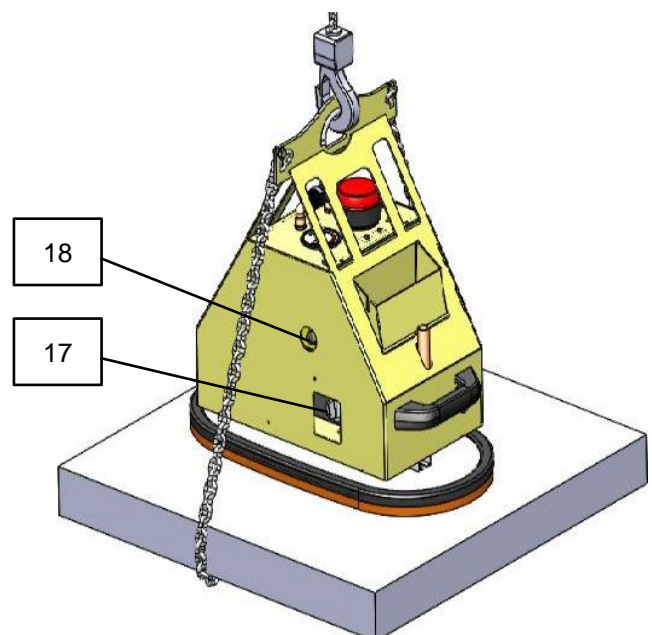
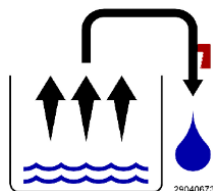

9.8 Piano di manutenzione

9.8.1 Impianto meccanico



Gli intervalli di seguito specificati andranno abbreviati in caso di utilizzo in condizioni difficoltose.

Intervallo	Lavori da svolgere
Primo intervento dopo 25 ore di utilizzo:	Controllare e, se necessario, stringere tutte le viti di fissaggio (l'operazione deve essere eseguita da un esperto).
Ogni 50 ore di funzionamento:	stringere tutte le viti di fissaggio e le connessioni (fare in modo che le viti siano strette conformemente alle coppie di serraggio in vigore per le classi di resistenza corrispondenti). Controllare tutti i giunti, i bulloni, gli ingranaggi per un corretto funzionamento, se necessario regolare o sostituire.

9.8.2 Restanti elementi costruttivi



La verifica annuale andrà eseguita da uno specialista (v. cap. o).

	Intervallo				
	Tutti i giorni	Settimanale	Mensile	Semestrale	Annuale
Controllo dei dispositivi di sicurezza: - Manometro OK? - Il dispositivo di avvertimento si inserisce in caso di sovrappressione/depressione corretta?	X				X
Controllare i filtri, sostituirli se necessario		X			X
Verificare lo stato di carica della batteria (indicatore pos. 7)	X				X
Sostituire la batteria se necessario					X
I tubi flessibili del vuoto sono in buone condizioni (non presentano rotture, incrinature, sfregamenti e sono dunque ermetici)?			X		X
Tutte le connessioni sono ermetiche (fascette stringitubo ecc.)?				X	X
I cartelli del modello, della capacità di carico e di avvertimento sono integri e completamente leggibili?					X
Il manuale operativo e di manutenzione è ancora disponibile e gli operatori ne sono a conoscenza?					X

Controllo degli elementi portanti (es. anello di sospensione, bulloni, linguette ...). Controllo per constatare eventuali crepe, deformazioni, usura, corrosione, sicurezza di funzionamento o altri danni.					X
Pulire le piastre di aspirazione / controllo, nessuna crepa, guarnizioni omogenee, ecc.? Ove necessario, procedere alla sostituzione		X			X
Il contrassegno è stato rinnovato?					X
Condizioni generali dell'apparecchio					X
Prova della tenuta			X		X
Drenaggio dell'acqua di condensa	X				X
Controllare lo stato della catena di sicurezza del carico 1)					X

1) Non appena il carico viene assorbito dalla catena di fissaggio del carico, la catena di fissaggio del carico deve essere testata professionalmente e, se necessario, sostituita. Le catene di fissaggio del carico danneggiate non devono più essere utilizzate!

9.9 Ispezione annua

L'azienda deve provvedere affinché l'apparecchio venga sottoposto all'ispezione di un esperto almeno una volta all'anno e che le anomalie riscontrate vengano tempestivamente eliminate (->cfr. regolamento DGUV 1-54 e regolamento DGUV 100-500).

Rispettare le disposizioni previste in materia dalle norme CE indicate nel certificato di conformità!!

L'ispezione peritale può essere eseguita anche dal produttore Probst GmbH. Contattateci all'indirizzo: service@probst-handling.com



Dopo l'esecuzione del controllo e l'eliminazione delle anomalie riscontrate sull'apparecchio raccomandiamo di applicare in un punto ben visibile la targhetta "Sachkundigenprüfung / Expert inspection".(Articolo-No.: 2904.0056+sticker di controllo con data)

 **Il controllo deve essere documentato da un esperto!**

Apparecchio	Anno	Data	Esperto	Società

9.10 Pulizia

Ai fini della pulizia del dispositivo di sollevamento, utilizzare unicamente pulitori a freddo (non nafta per pulitura a secco o liquidi irritanti, che potrebbero rendere i tubi non più ermetici o addirittura disintegrarli). La pulizia delle piastre di aspirazione può avvenire con sapone e acqua calda, non utilizzare pulitori a freddo sulle guarnizioni degli aspiratori!

9.11 Pezzi di ricambio

Risponderemo con la garanzia prevista unicamente sui pezzi di ricambio originali da noi forniti. Probst GmbH esclude qualsivoglia responsabilità e concessione della garanzia per qualsiasi danno derivante dall'utilizzo di ricambi e accessori non originali.

Per ogni ordinazione di pezzi di ricambio, si prega di indicare numero di commessa, numero di serie del dispositivo di sollevamento così come numero articolo dell'elemento in questione (v. targhetta segnaletica ed elenco dei pezzi di ricambio).

10 Messa fuori servizio e smaltimento

Il dispositivo di sollevamento può essere messo fuori servizio e preparato per lo smaltimento unicamente da personale tecnico qualificato.

Procedura:

1. separare il dispositivo di sollevamento dal mezzo di trasporto e sollevamento.
2. Smontare la batteria e smaltirla correttamente (v. cap. 9.2).
3. Smontare la piastra di aspirazione e smaltirla.
4. Allentare le fascette stringitubo ed estrarre i tubi flessibili.
5. Smontare il corpo della base e smaltirlo.

Ai fini del corretto smaltimento si prega di rivolgersi a un'azienda per lo smaltimento di apparecchi tecnici, facendo attenzione a osservare le disposizioni ambientali e per lo smaltimento vigenti in materia in quel preciso momento. Il produttore dell'apparecchio vi sarà d'aiuto nella ricerca di un'azienda appropriata.

Certificato di manutenzione



Le richieste di garanzia sono valide solo se il programma di manutenzione specificato è stato adeguatamente rispettato (presso un officina specializzata). Dopo ogni intervento di manutenzione il seguente modulo deve essere compilato, timbrato e firmato e spedito a noi immediatamente. ¹⁾

¹⁾ via e-mail a: service@probst-handling.de / via fax o post

Operatore: _____
 Modello apparecchio: _____ Articolo N.: _____
 Apparecchio N.: _____ Anno di fabbricazione: _____

Prima ispezione dopo 25 ore di funzionamento		
Data:	Lavoro di manutenzione:	Ispezione effettuata da:
		<i>Timbro</i>
	
		Nome / Firma

Dopo 50 ore di funzionamento		
Data:	Lavoro di manutenzione:	Ispezione effettuata da:
		<i>Timbro</i>
	
		Nome / Firma
		Ispezione effettuata da:
		<i>Timbro</i>
	
		Nome / Firma
		Ispezione effettuata da:
		<i>Timbro</i>
	
		Nome / Firma

Minimo 1 volta all'anno		
Data:	Lavoro di manutenzione:	Ispezione effettuata da:
		<i>Timbro</i>
	
		Nome / Firma
		Ispezione effettuata da:
		<i>Timbro</i>
	
		Nome / Firma

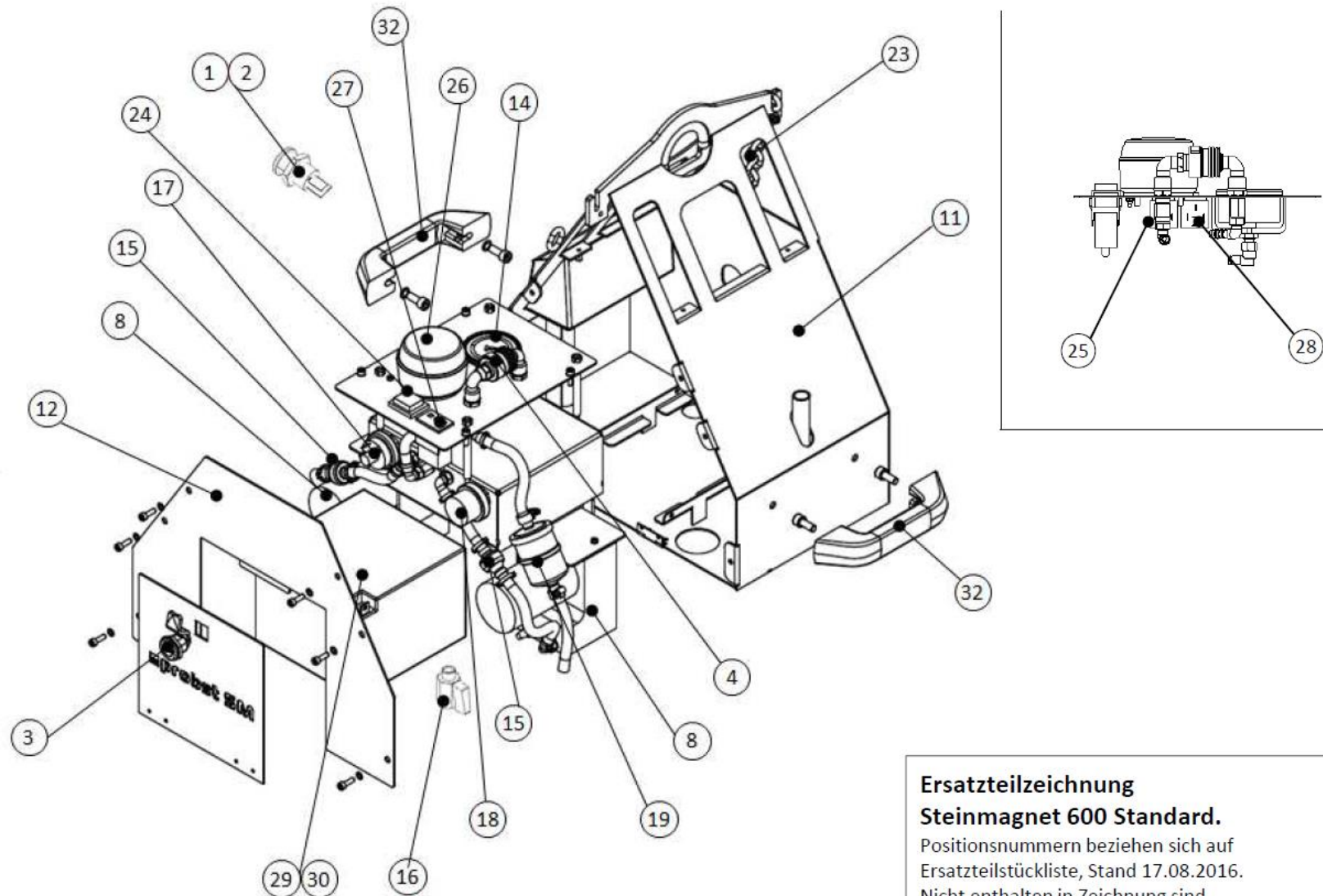

**Ersatzteilzeichnung
Steinmagnet 600 Standard.**

Positionsnummern beziehen sich auf
Ersatzteilstückliste, Stand 17.08.2016.
Nicht enthalten in Zeichnung sind
Pos 13, 20, 21, 22 und 31

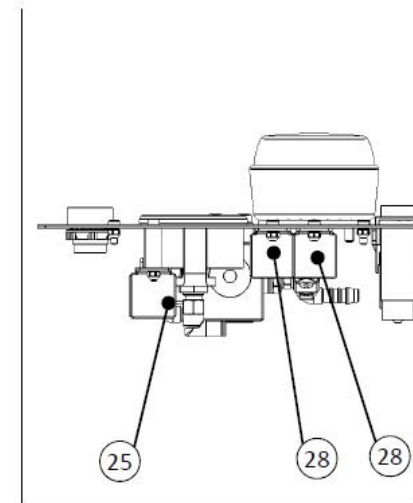
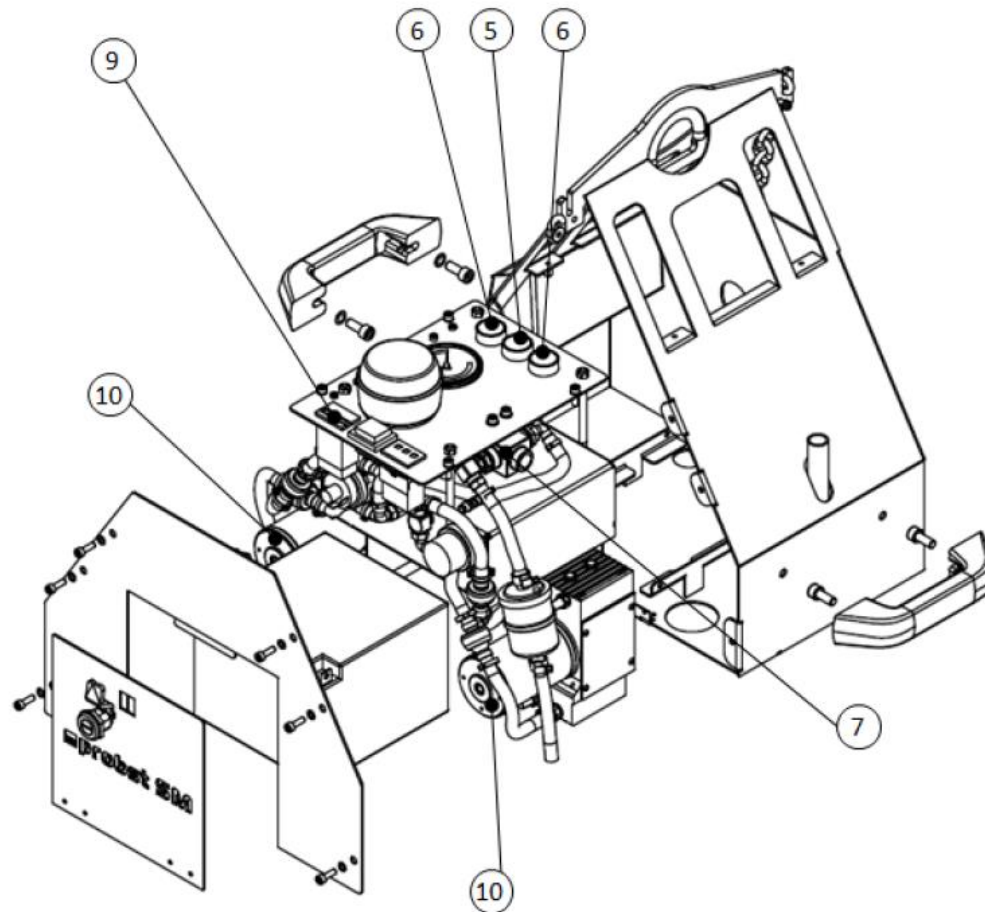

**Ersatzteilzeichnung
Steinmagnet 600 Power und
Steinmagnet 600 Power mit FFS.**





Positionsnummern beziehen sich auf
Ersatzteilstückliste, Stand 17.08.2016.
Nicht enthalten in Zeichnung sind
Pos 13, 20, 21, 22 und 31

Ersatzteilliste / Spare Parts List

SM-600 / SM-600-POWER / SM-600-POWER-FFS

Pos.	Verwendung / Use	Bezeichnung / Description	Artikel-Nr. Part-Nr.	
1	SM-600 SM-600-POWER SM-600-POWER-FFS	Built-in female connector LADEBUCHSE für KFZ-Normstecker 18 12 SW	2410.0404	
2	SM-600 SM-600-POWER SM-600-POWER-FFS	Sealing plug (el) Abdeckung für Ladebuchse	2410.0405	
3	SM-600 SM-600-POWER SM-600-POWER-FFS	Battery lock Batterieschloss M20-AG 28x32	4272.0354	
4	SM-600	Manual slide valve for manual switching of vacuum and compressed air Handschiebeventil HSV 3/2 S	2307.1001	
5	SM 600 Power SM-600-POWER-FFS	Pushbutton momentary for warning device Drucktaster für Warngerät RT 28.5	2411.0054	
6	SM-600-POWER SM-600-POWER-FFS	Pushbutton momentary red Drucktaster rot 28.5	2411.0181	
7	SM-600-POWER SM-600-POWER-FFS	Solenoid valve EMV Elektromagnetventil EMV 12 12V-DC 3/2 NO	2203.0097	
8	SM-600	Vacuum pump Vakuumpumpe EVE-TR-M 2.2 12V-DC	2530.0053	
9	SM-600-POWER SM-600-POWER-FFS	Timer Betriebsstundenzähler 24V-DC-St	2420.0133	
10	SM-600-POWER SM-600-POWER-FFS	Vacuum pump Vakuumpumpe EVE-TR-M 4.4 12V-DC	2530.0061	
11	SM-600 SM-600-POWER SM-600-POWER-FFS	Housing SM-600 Gehäuse SM-600	4272.0356	
12	SM-600 SM 600-POWER SM-600-POWER-FFS	Housing cover Gehäuseabdeckung	4272.0357	
13	SM-600-POWER-FFS	Radio remote control for switching the equipment on and off Funkfernsteuerung FFS	4272.0346	
14	SM-600 SM-600-POWER SM-600-POWER-FFS	Vacuum gauge (manometer) Vakuumanometer VAM 67 V H-SE	2213.0015	

15	SM-600 SM-600-POWER SM-600-POWER-FFS	No-return valve Rückschlagventil RSV 10.2	2204.0027	
16	SM-600 SM-600-POWER SM-600-POWER-FFS	Two-way drainage valve 2/2-Wege-Kugelhanhn KVZ 8 2/2	2206.0009	
17	SM-600 SM-600-POWER SM-600-POWER-FFS	Vacuum/pressure switch, Druckschalter	2290.0003	
18	SM-600 SM-600-POWER SM-600-POWER-FFS	Vacuum/pressure switch Druckschalter	2290.0004	
19	SM-600 SM-600-POWER SM-600-POWER-FFS	Filter insert (round) Filtereinsatz PAP VM-SM	4271.0004	
20	SM-600 SM-600-POWER SM-600-POWER-FFS	Hose clamp for securing smooth hoses Schlauchschelle	2105.0111	
21	SM-600 SM-600-POWER SM-600-POWER-FFS	Two-ear clamp 2-Ohr-Schellen	2105.0066	
22	SM-600 SM-600-POWER SM-600-POWER-FFS	Two-ear clamp 2-Ohr-Schellen	2105.0180	
23	SM-600 SM-600-POWER SM-600-POWER-FFS	Chain Sicherheitskette	2100.0009	
24	SM-600 SM-600-POWER SM-600-POWER-FFS	Switch closing contact SCHALTER 250V-AC 6A 2	2411.0032	
25	SM-600 SM-600-POWER SM-600-POWER-FFS	Relay RELAIS 50A 12V-DC 1U	2402.0014	
26	SM-600 SM-600-POWER SM-600-POWER-FFS	Warning lamp / Flash light WARNLEUCHTE	2418.0009	
27	SM-600 SM-600-POWER SM-600-POWER-FFS	Vehicle voltage monitor Spannungsüberwachung 36x24 VM-SM	2436.0013	
28	SM-600 SM-600-POWER SM-600-POWER-FFS	Relay RELAIS 40A 12V-DC 1S	2402.0008	
29	SM-600 SM-600-POWER SM-600-POWER-FFS	Battery BATTERIE 167x175x125-12V-DC	2420.0008	

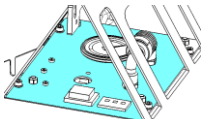
30	SM-600 SM-600-POWER SM-600-POWER-FFS	Connection cable Verbindungskabel	4272.0355	
31	SM-600 SM-600-POWER SM-600-POWER-FFS	Silicone hose Silikonschlauch	4272.0027	
32	SM-600 SM-600-POWER SM-600-POWER-FFS	U-handle Handtragegriff 196	2160.0020	
33	SM-600-POWER SM-600-POWER-FFS	Abdeckblech oben Top cover	4272.0386	
34	SM-600	Abdeckblech oben Top cover	4272.0389	

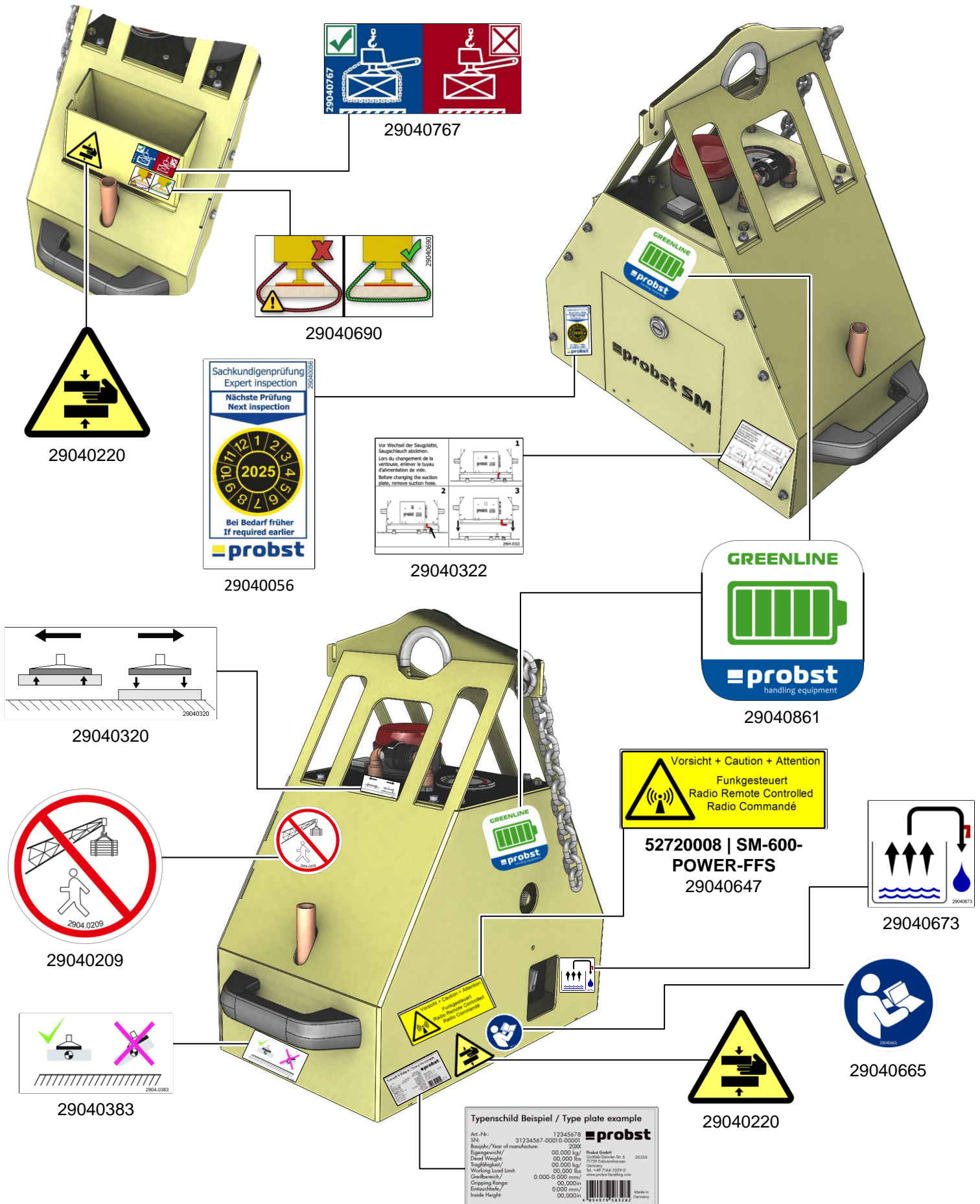

DE	Bitte beachten Sie, dass das Produkt ohne vorliegende Betriebsanleitung in Landessprache nicht eingesetzt / in Betrieb gesetzt werden darf. Sollten Sie mit der Lieferung des Produkts keine Betriebsanleitung in Ihrer Landessprache erhalten haben, kontaktieren Sie uns bitte. In Länder der EU / EFTA senden wir Ihnen diese kostenlos nach. Für Länder außerhalb der EU / EFTA erstellen wir Ihnen gerne ein Angebot für eine Betriebsanleitung in Landessprache, falls die Übersetzung nicht durch den Händler/Importeur organisiert werden kann.
GB	Please note that the product may not be used / put into operation without these operating instructions in the national language. If you did not receive operating instructions in your national language with the delivery of the product, please contact us. In countries of the EU / EFTA we will send them to you free of charge. For countries outside the EU / EFTA, we will be pleased to provide you with an offer for an operating manual in the national language if the translation cannot be organised by the dealer/importer.
FR	Veillez noter que le produit ne doit pas être utilisé / mis en service sans le présent mode d'emploi dans la langue du pays. Si vous n'avez pas reçu de mode d'emploi dans votre langue lors de la livraison du produit, veuillez nous contacter. Dans les pays de l'UE / AELE, nous vous l'enverrons gratuitement. Pour les pays en dehors de l'UE / AELE, nous vous soumettons volontiers une offre pour un mode d'emploi dans la langue du pays si la traduction ne peut pas être organisée par le revendeur / l'importateur.
IT	Si prega di notare che il prodotto non può essere utilizzato/messo in funzione senza le istruzioni per l'uso nella lingua locale. Se con la consegna del prodotto non avete ricevuto le istruzioni per l'uso nella vostra lingua nazionale, contattateci. Le invieremo gratuitamente nei Paesi UE/EFTA. Per i Paesi al di fuori dell'UE/EFTA, saremo lieti di fornirvi un preventivo per le istruzioni per l'uso nella lingua locale se la traduzione non può essere organizzata dal rivenditore/importatore.
NL	Houd er rekening mee dat het product niet mag worden gebruikt / in gebruik genomen zonder bedieningshandleiding in de lokale taal. Als u bij de levering van het product geen bedieningshandleiding in uw landstaal hebt ontvangen, neem dan contact met ons op. Wij sturen u deze gratis toe in de EU/EVA-landen. Voor landen buiten de EU/EVA doen wij u graag een voorstel voor een gebruiksaanwijzing in de lokale taal als de vertaling niet kan worden geregeld door de dealer/importeur.
ES	Tenga en cuenta que el producto no puede utilizarse / ponerse en funcionamiento sin instrucciones de uso en el idioma local. Si no ha recibido las instrucciones de funcionamiento en su idioma nacional con la entrega del producto, póngase en contacto con nosotros. Se las enviaremos gratuitamente en los países de la UE / AELC. Para los países fuera de la UE / AELC, estaremos encantados de proporcionarle un presupuesto para las instrucciones de funcionamiento en el idioma local si la traducción no puede ser organizada por el distribuidor / importador.
PL	Należy pamiętać, że produkt nie może być używany / uruchamiany bez instrukcji obsługi w lokalnym języku. Jeśli wraz z produktem nie dostarczono instrukcji obsługi w języku danego kraju, prosimy o kontakt. Wyślemy ją bezpłatnie w krajach UE/EFTA. W przypadku krajów spoza UE / EFTA z przyjemnością przedstawimy wycenę instrukcji obsługi w języku lokalnym, jeśli sprzedawca / importer nie może zorganizować tłumaczenia.
BG	Моля, обърнете внимание, че продуктът не може да се използва/въвежда в експлоатация без инструкции за експлоатация на местния език. Ако с доставката на продукта не сте получили инструкциите за експлоатация на вашия национален език, моля, свържете се с нас. Ние ще ви ги изпратим безплатно в страните от ЕС/ЕАСТ. За страните извън ЕС/ЕАСТ с удоволствие ще Ви предоставим оферта за инструкции за експлоатация на местния език, ако преводът не може да бъде организиран от търговеца/вносителя.
DK	Vær opmærksom på, at produktet ikke må anvendes / tages i brug uden en betjeningsvejledning på det lokale sprog. Hvis du ikke har modtaget en betjeningsvejledning på dit nationale sprog ved levering af produktet, bedes du kontakte os. Vi sender den gratis til dig i EU/EFTA-lande. I lande uden for EU/EFTA giver vi gerne et tilbud på en brugsanvisning på det lokale sprog, hvis oversættelsen ikke kan organiseres af forhandleren/importøren.
ET	Pange tähele, et toodet ei tohi kasutada / kasutusele võtta ilma kohaliku keele koostatud kasutusjuhendita. Kui te ei ole toote tarnimisel saanud kasutusjuhendit teie riigikeeles, võtke meiega ühendust. Me saadame need teile tasuta ELI/EFTA riikides. Väljaspool ELI/EFTA riike esitame teile hea meelega pakkumise kohalikus keeles kasutusjuhendi saamiseks, kui edasimüüja/importija ei saa tõlkimist korraldada.
FI	Huomaa, että tuotetta ei saa käyttää / ottaa käyttöön ilman paikalliskielisiä käyttöohjeita. Jos et ole saanut käyttöohjeita kansallisella kielelläsi tuoteen toimituksen yhteydessä, ota meihin yhteyttä. Lähetämme ne sinulle maksutta EU- / EFTA-maissa. EU:n / EFTA:n ulkopuolisissa maissa annamme mielellämme tarjouksen käyttöohjeista paikallisella kielellä, jos jälleenmyyjä / maahantuoja ei voi järjestää käännöstä.
GR	Λάβετε υπόψη ότι το προϊόν δεν επιτρέπεται να χρησιμοποιηθεί/να τηθεί σε λειτουργία χωρίς οδηγίες λειτουργίας στην τοπική γλώσσα. Εάν δεν έχετε λάβει οδηγίες λειτουργίας στην εθνική σας γλώσσα με την παράδοση του προϊόντος, παρακαλούμε επικοινωνήστε μαζί μας. Θα σας τις στείλουμε δωρεάν στις χώρες της ΕΕ / ΕΖΕΣ. Για χώρες εκτός ΕΕ / ΕΖΕΣ, θα χαρούμε να σας παραχώμε προσφορά για οδηγίες λειτουργίας στην τοπική γλώσσα, εάν η μετάφραση δεν μπορεί να οργανωθεί από τον αντιπρόσωπο / εισαγωγέα.
IS	Vinsamlega athugið að ekki má nota/taka í notkun vöruna nema notkunarléiðbeiningar séu á heimatungumáli. Ef þú fékkst ekki notkunarhandbók á þínu tungumáli þegar varan var afhent, vinsamlegast hafðu samband við okkur. Við munum senda þér þetta ókeypis til ESB / EFTA landa. Fyrir lönd utan ESB / EFTA munum við gjarnan veita þér tilboð um notkunarhandbók á heimatungumáli ef söluáðili/innflytjandi getur ekki skipulagt þýðinguna.
HR	Imajte na umu da se proizvod ne smije koristiti/pustiti u rad bez uputa za uporabu na lokalnom jeziku. Ako niste primili priručnik za uporabu na vašem lokalnom jeziku kada je proizvod isporučen, kontaktirajte nas. Poslat ćemo vam ih besplatno u zemlje EU / EFTA. Za zemlje izvan EU / EFTA, rado ćemo vam pružiti ponudu za priručnik za uporabu na lokalnom jeziku ako prijevod ne može organizirati trgovac/uvoznik.
LV	Lūdzu, ņemiet vērā, ka izstrādājumu nedrīkst lietot/nodot ekspluatācijā bez lietošanas instrukcijas vietējā valodā. Ja līdz ar izstrādājuma piegādi neesat saņēmis lietošanas instrukciju valsts valodā, lūdzu, sazinieties ar mums. ES/EFTA valstīs mēs jums tās nosūtīsim bez maksas. Valstīs ārpus ES/EFTA valstīm, ja tulkojumu nevarēs nodrošināt tirgotājs/importētājs, mēs labprāt sniegsim jums ekspluatācijas instrukciju vietējā valodā.
LT	Atkreipkite dėmesį, kad gaminio negalima naudoti ir (arba) pradėti eksploatuoti be naudojimo instrukcijos vietine kalba. Jei kartu su gaminiu pristatymu negavote naudojimo instrukcijos savo šalies kalba, susisiekite su mumis. ES / ELPA šalyse jas išsiųsime nemokamai. ES / ELPA nepriklausančiose šalyse mes mielai pateiksime jums eksploatavimo instrukcijų vietine kalba pasiūlymą, jei pardavėjas / importuotojas negalės išversti instrukcijų į vietinę kalbą.
NO	Vær oppmerksom på at produktet ikke må brukes/tas i bruk uten en bruksanvisning på det lokale språket. Hvis du ikke har mottatt en bruksanvisning på ditt eget språk ved levering av produktet, ber vi deg ta kontakt med oss. Vi sender deg bruksanvisningen kostnadsfritt i EU/EFTA-land. For land utenfor EU/EFTA gir vi deg gjerne et tilbud på en bruksanvisning på det lokale språket hvis oversættelsen ikke kan ordnes av forhandleren/importøren.
PT	Tenha em atenção que o produto não pode ser utilizado/colocado em funcionamento sem um manual de instruções na língua local. Se não tiver recebido o manual de instruções na sua língua nacional com a entrega do produto, contacte-nos. O envio é gratuito nos países da UE / EFTA. Para os países fora da UE / EFTA, teremos todo o gosto em fornecer-lhe um orçamento para o manual de instruções na língua local, se a tradução não puder ser organizada pelo revendedor / importador.
RO	Vă rugăm să rețineți că produsul nu poate fi utilizat / pus în funcțiune fără instrucțiuni de utilizare în limba locală. Dacă nu ați primit instrucțiuni de utilizare în limba dvs. națională odată cu livrarea produsului, vă rugăm să ne contactați. Vi le vom trimite gratuit în țările UE / AELS. Pentru țările din afara UE / AELS, vom fi bucuroși să vă furnizăm o ofertă pentru instrucțiuni de utilizare în limba locală, dacă traducerea nu poate fi organizată de către dealer / importator.
SE	Observera att produkten inte får användas / tas i drift utan bruksanvisning på det lokala språket. Om du inte har fått en bruksanvisning på ditt språk i samband med leveransen av produkten, vänligen kontakta oss. Vi skickar dem kostnadsfritt till dig i EU / EFTA-länder. För länder utanför EU / EFTA ger vi dig gärna en offert på bruksanvisningar på det lokala språket om översättningen inte kan organiseras av återförsäljaren / importören.
SK	Upozorňujeme, že výrobok sa nesmie používať/uvádzať do prevádzky bez návodu na obsluhu v miestnom jazyku. Ak ste spolu s výrobkom nedostali návod na obsluhu vo vašom národnom jazyku, kontaktujte nás. V krajinách EÚ/EZVO vám ich zašleme bezplatne. V krajinách mimo EÚ/EZVO vám radi poskytneme cenovú ponuku na návod na obsluhu v miestnom jazyku, ak preklad nemôže zabezpečiť predajca/dovozca.
SL	Upoštevajte, da izdelka ne smete uporabljati brez navodil za uporabo v lokalnem jeziku. Če z dostavo izdelka niste prejeli navodil za uporabo v nacionalnem jeziku, se obrnite na nas. V državah EU/EFTA vam jih bomo poslali brezplačno. Za države zunaj EU/EFTA vam bomo z veseljem pripravili ponudbo za navodila za uporabo v lokalnem jeziku, če prevoda ne more zagotoviti prodajalec/uvoznik.
CZ	Upozorňujeme, že výrobek nesmí být používán / uveden do provozu bez návodu k obsluze v místním jazyce. Pokud jste spolu s výrobkem neobdrželi návod k obsluze ve svém národním jazyce, kontaktujte nás. V zemích EU/EFTA vám je zašleme zdarma. V zemích mimo EU/EFTA vám rádi poskytneme nabídku návodu k obsluze v místním jazyce, pokud překlad nemůže zajistit prodejce/dovozce.
HU	Felhívjuk figyelmét, hogy a termék nem használható/helyezhető üzembe a helyi nyelven kiadott használati utasítás nélkül. Ha a termék szállításával együtt nem kapta meg a nemzeti nyelven készült használati utasítást, kérjük, lépjen kapcsolatba velünk. Az EU/EFTA-országokban ingyenesen elküldjük Önnek. Az EU / EFTA-n kívüli országok esetében szívesen adunk Önnek árajánlatot a helyi nyelvű kezelési útmutatóra, ha a fordítást a kereskedő / importőr nem tudja megszervezni.